

# Showering at the LHC

Deepak Kar

University of Glasgow/Witwatersrand

UCL HEP Seminar  
17th March, 2015

# Outline

Tuning



Phenomenological  
Models

Compare with  
model predictions

Measure distributions  
sensitive to softQCD

Application in jet substructure/top tagging

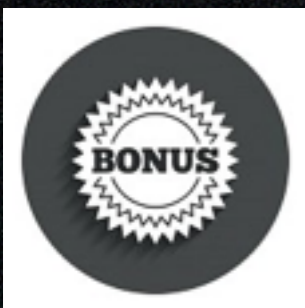

# Soft-QCD

$$\sigma_{\text{total}} = \sigma_{\text{el}} + \sigma_{\text{sd}} + \sigma_{\text{dd}} + \sigma_{\text{nd}}$$

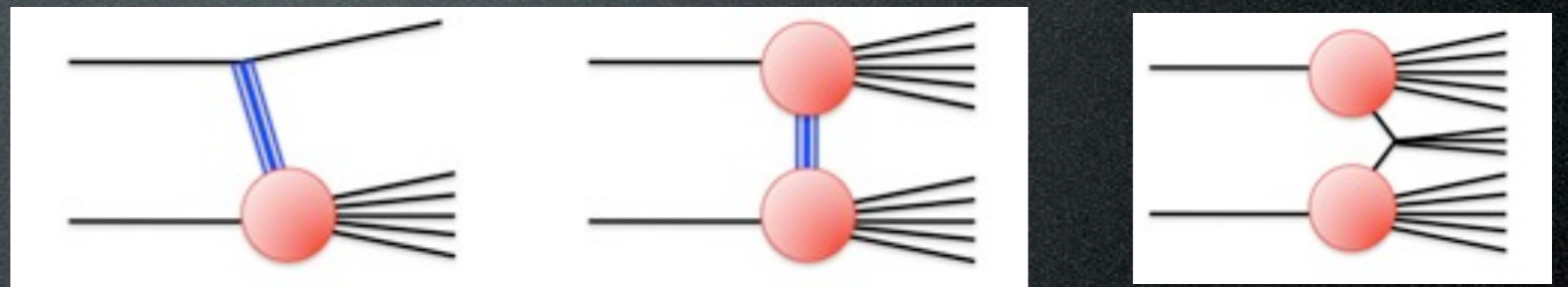

# Soft-QCD

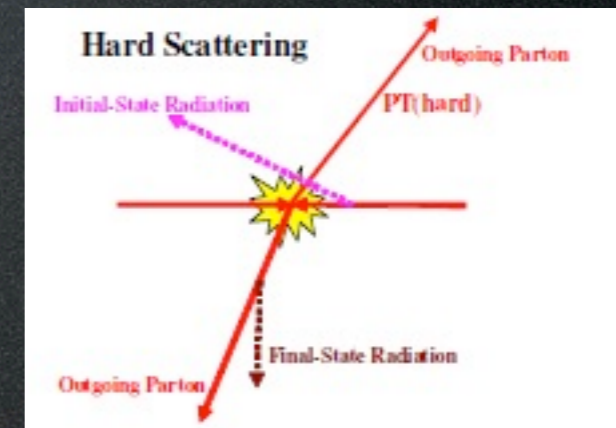
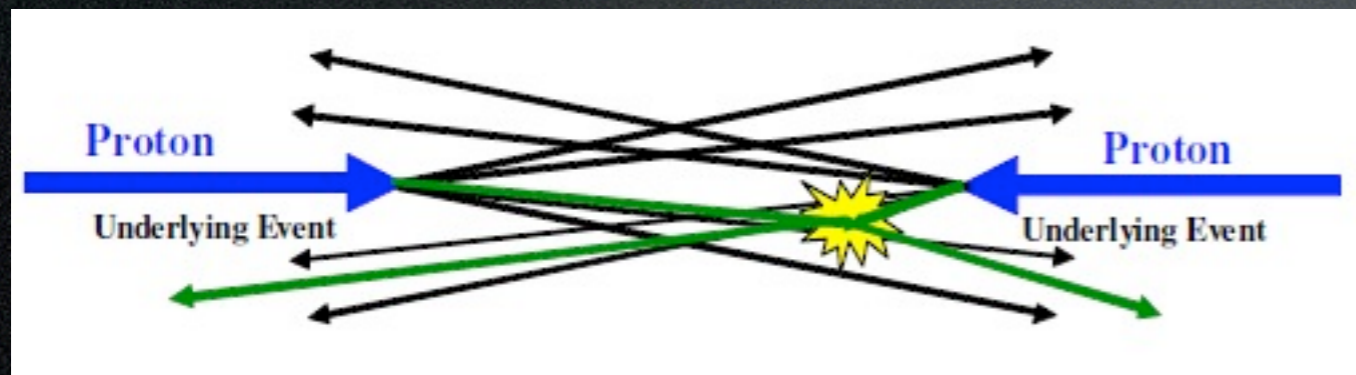
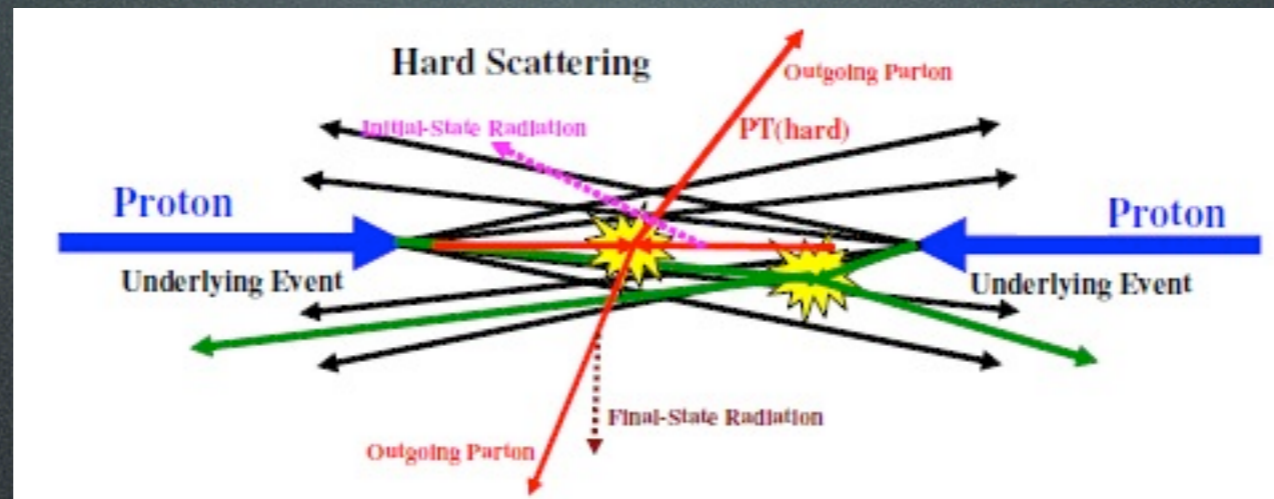

Underlying event = BBR+ MPI+ (ISR+FSR)

BBR: Beam-beam remnants  
MPI: Multiple Parton interactions  
ISR/FSR: Initial/Final state radiation

# Glossary

- Minimum-bias (MB): Pretty much everything, exact definition trigger dependent.
- Underlying event (UE): background to events with an identified hard scatter (more like the actual interesting events we want to look at)
- Pileup (PU): (uncorrelated) separate collisions within the same/different bunch crossing we can't differentiate because of our finite detector resolution (more like "isotropic" min-bias events).

# Monte Carlo Models

- Leading order/Parton shower models: Trying to build up a complex  $2 \rightarrow N$  final state by showers.
- Pieces of a Parton-Shower MC Generator: ( $2 \rightarrow 2$  hard scattering), ISR, FSR, MPI, Fragmentation, Hadronization.
- Examples: Pythia, Herwig family.
- Higher order/Multileg generators: Sherpa, AlpGen, aMC@NLO, Madgraph, Powheg ...
- Generators used mostly for a specific process: Phojet (diffraction), HIJING (heavy ion), AcerMC (top), JHU (spin and polarization information)...

Hard Process

Parton Shower

Hadronization

Decays

Multi Parton Interaction

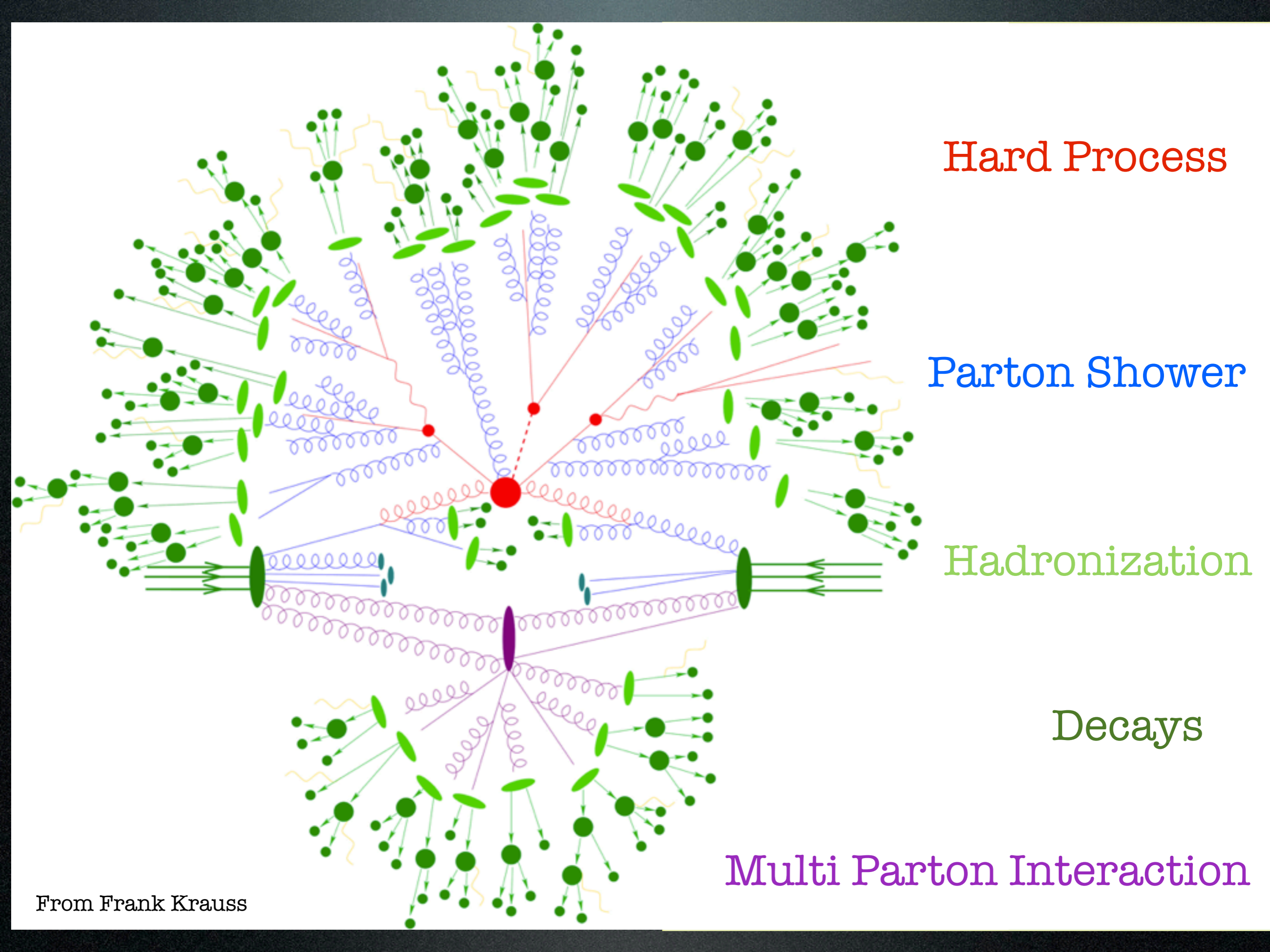

# Parton Shower

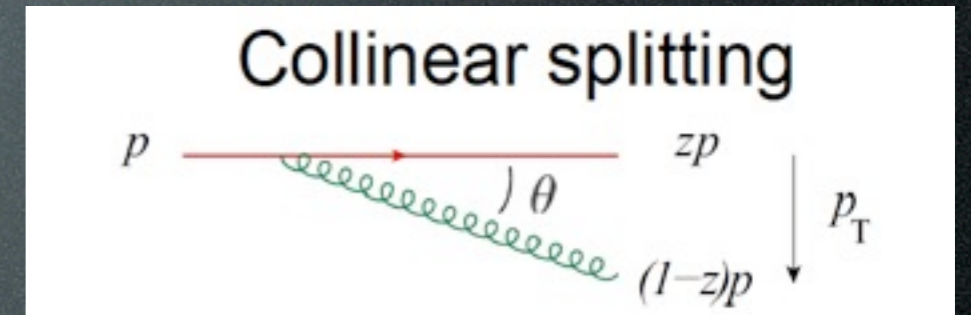
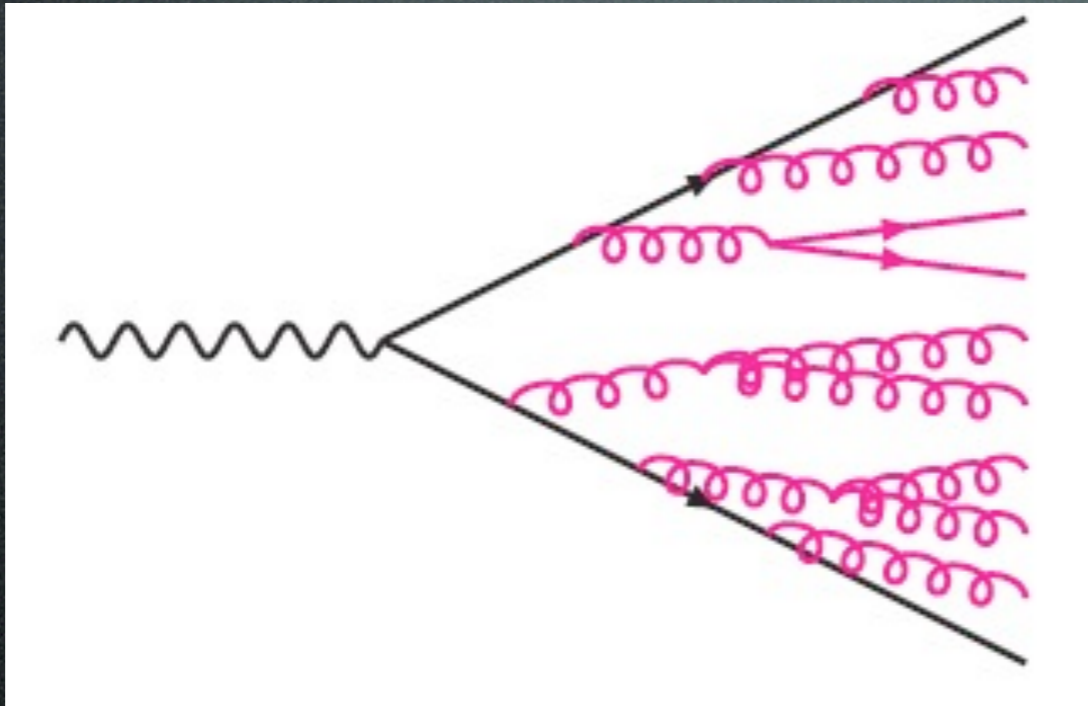

- Probability that a branching happens at a given time is given by Sudakov Form Factor.
- Each branching governed by DGLAP equation.
- Branching continues until each parton finally undergoes transitions to hadrons that can be observed.



# A Note on the Models

“The predictions of the model are reasonable enough physically that we expect it may be close enough to reality to be useful in designing future experiments and to serve as a reasonable approximation to compare to data. We do not think of the model as a sound physical theory . . . .”

– Richard Feynman and Rick Field, 1978



# Why do we care?

- The “background” to the interesting physics signals are the SM processes.
- The hard scattering part can be calculated theoretically (in some order) by QCD matrix elements.
- The soft part is not calculable, so we use phenomenological models implemented in Monte Carlo event generators.

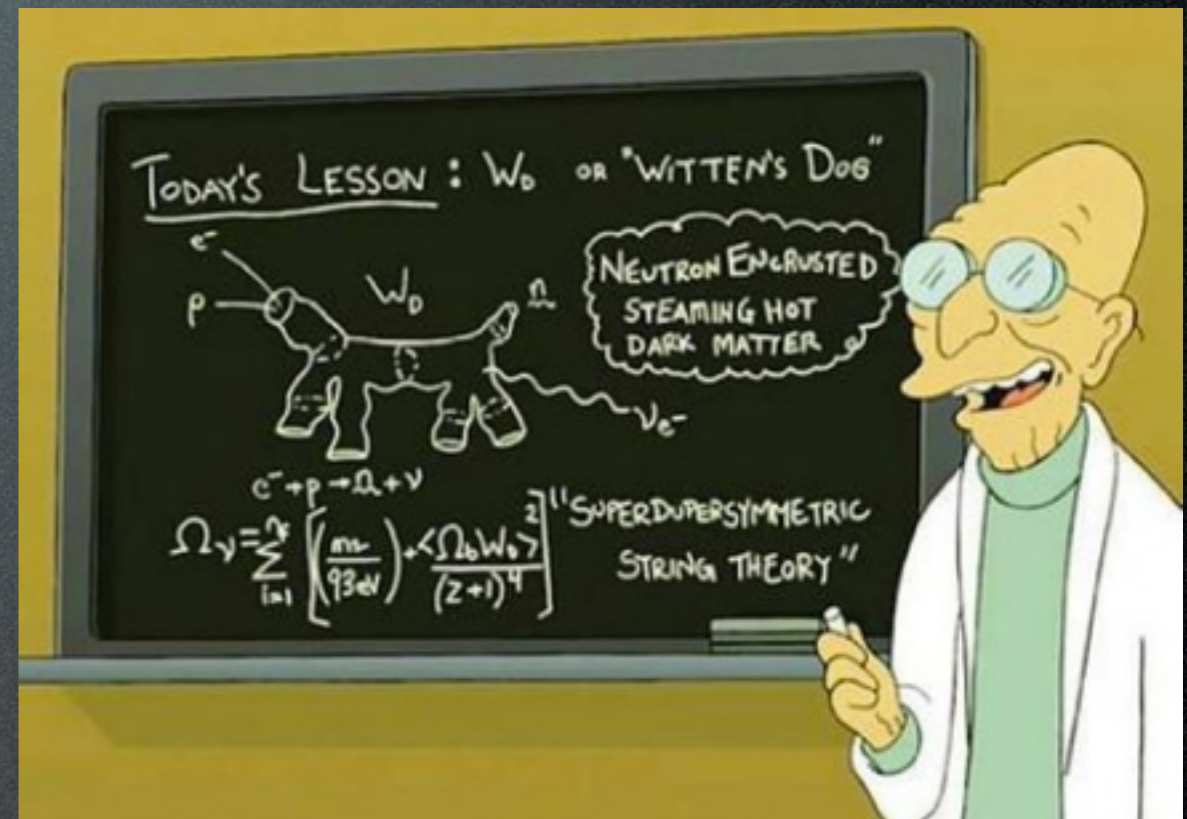

# An Example

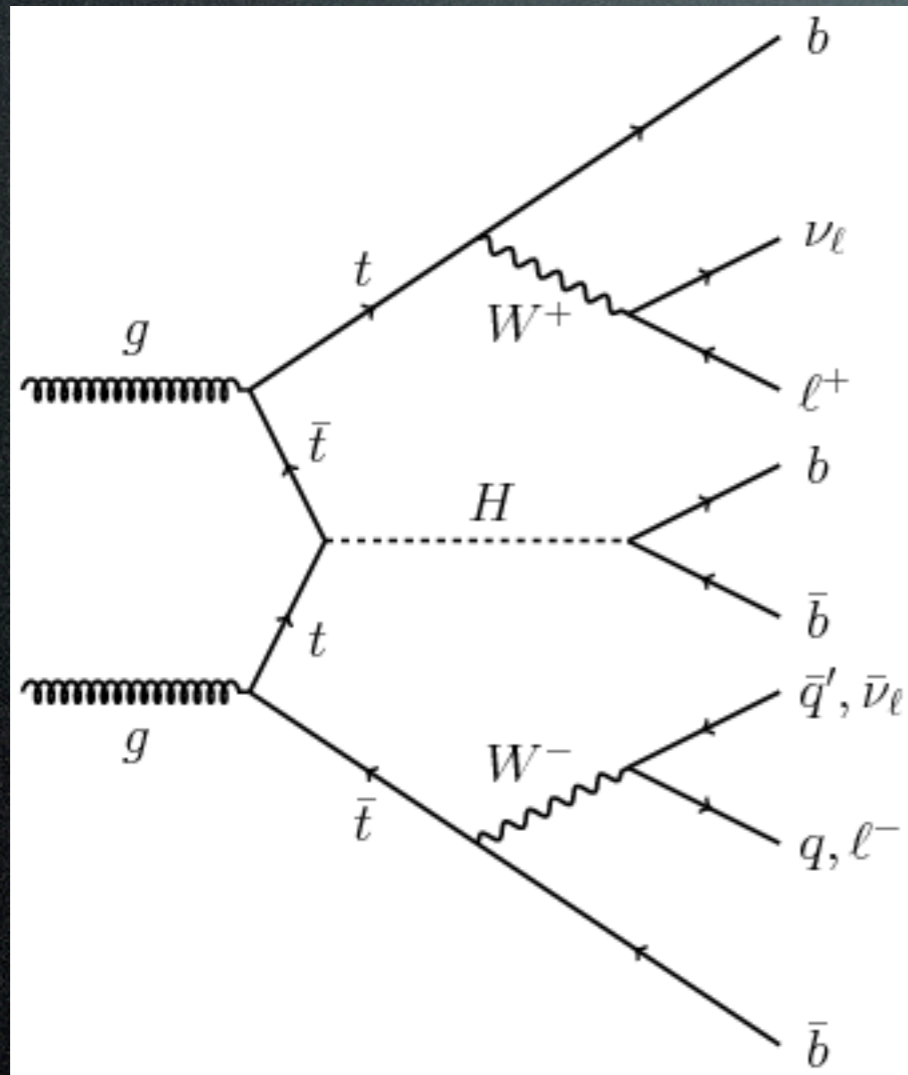

Signal:  $ttH(bb)$

*important for measuring Yukawa couplings*

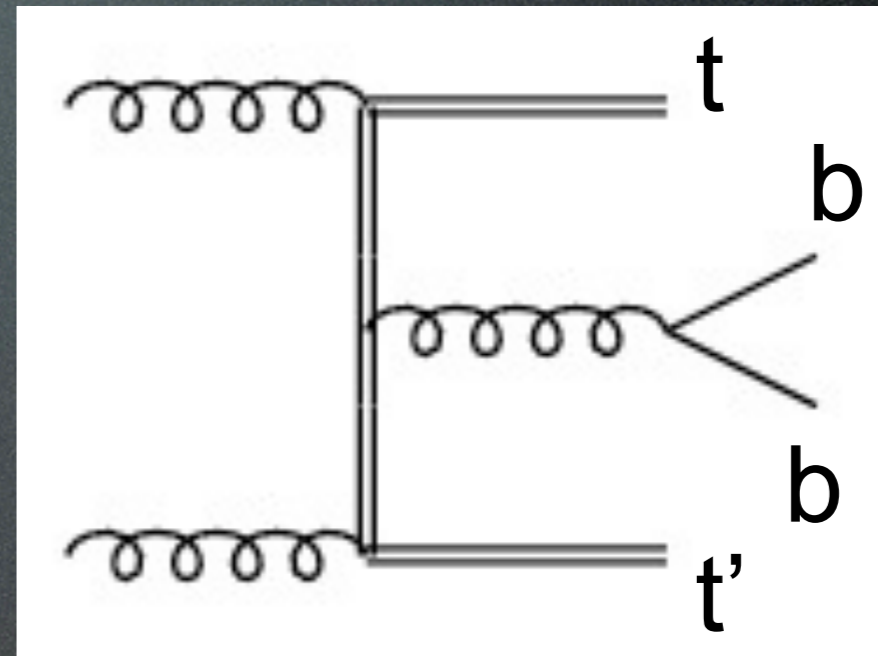

BG:  $ttbb$

One of the hardest measurements now...

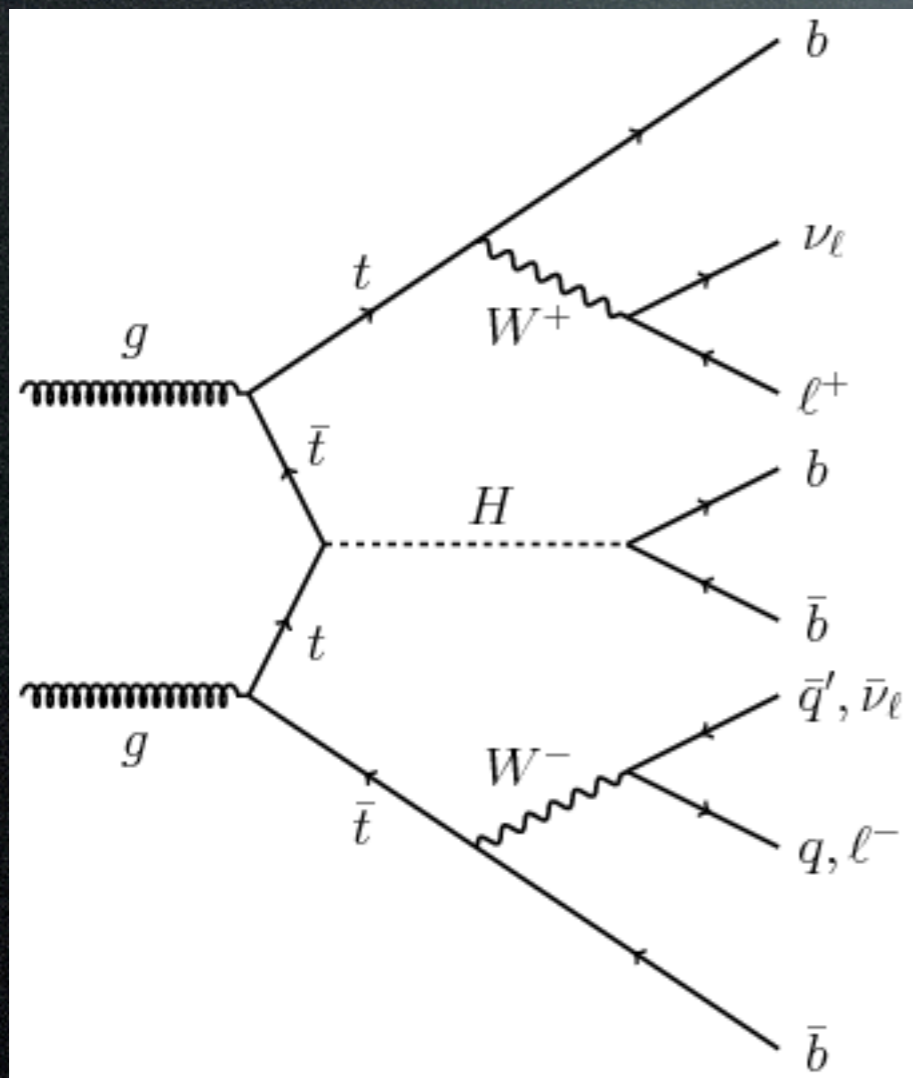

Signal:  $ttH(bb)$

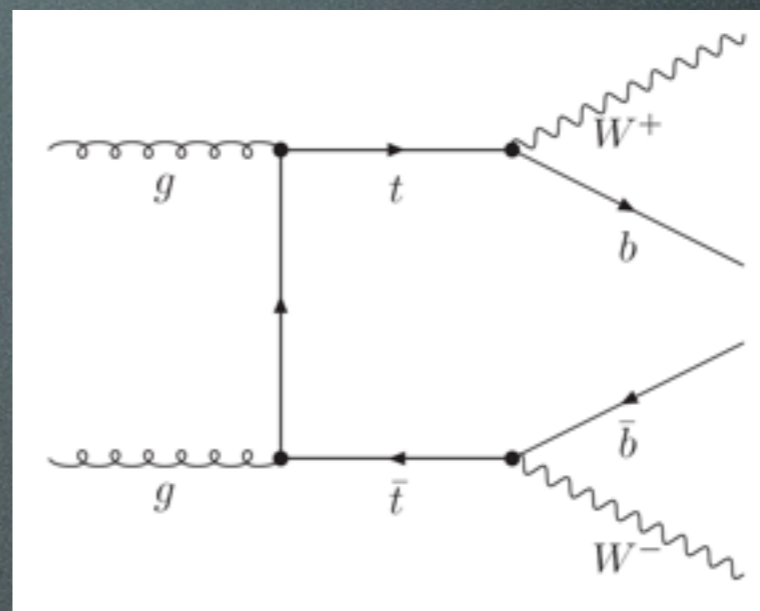

$t\bar{t}$

+

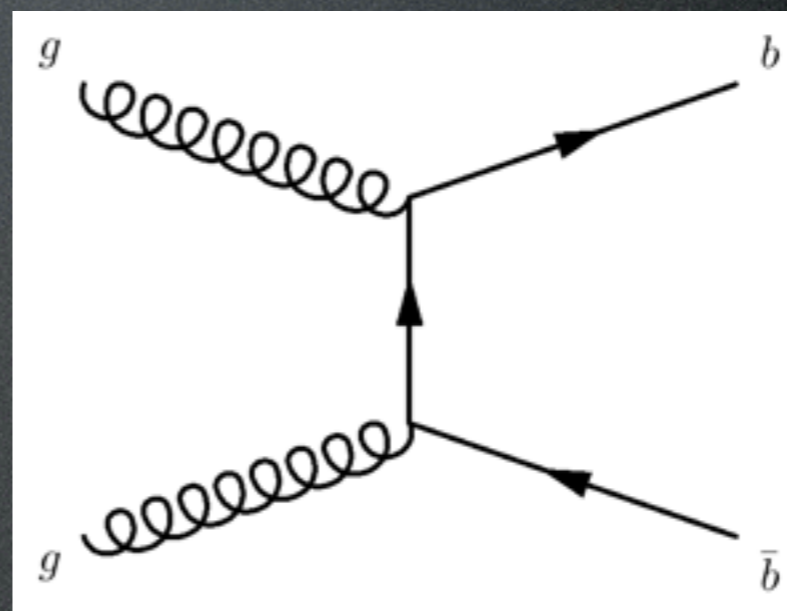

(DPI)  $b\bar{b}$

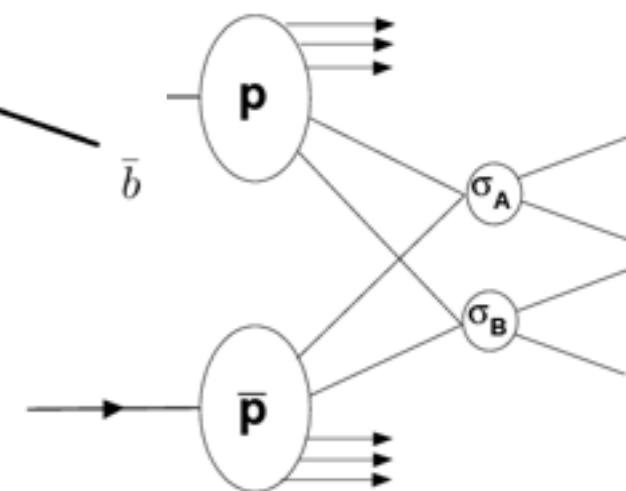

# Tuning

- Ultimate goal: models need to describe real data.
- “Free” parameters control all these aspects of the models, which cannot be derived analytically.
- A bunch of correlated (or anti-correlated) parameters describe one aspect, so have to change them simultaneously.



Tune: A particular optimized parameter setting in a particular MC generator to match the simulation with available data. Differ according to which datasets are included.

# A Brief History of Tuning

- Historically most effort has been devoted to tuning (Fortran) Pythia6, even at LEP/CDF.
- ATLAS did tune (Fortran) Herwig+Jimmy(which adds MPI), and now (C++) Pythia8.
- (C++) Herwig++, Sherpa has so far been tuned by authors.



Apollo's priestess, Pythia, performing the duty of the oracle

- Hadronization and FSR: LEP
- ISR and MPI: Hadron colliders

# Tuning Procedure

- Tuning-by-eye: the classical approach. Stare at a few distributions, think hard, change some parameters, hope those are better, nothing else is broken. Very intuition/experience dependent.
- Automated tuning tool/Professor: pioneered by ATLAS. Essentially generate lot of samples covering the parameter space. Interpolate the generator response, get the best fit by minimization. (and burn a lot of CPU)

Tune Jungle?

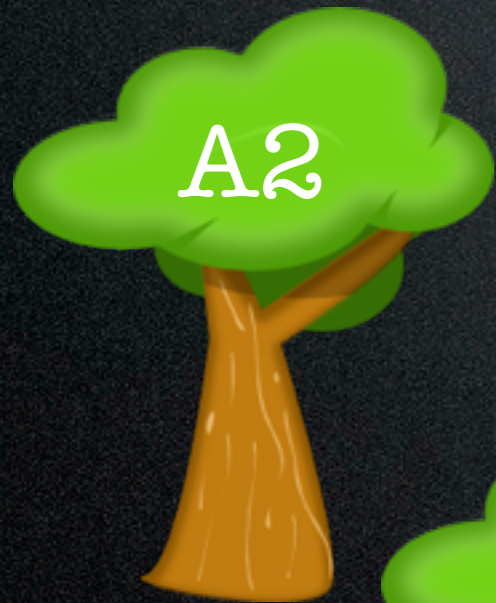



# Tevatron Era Tunes

- CDF/Rick Field tunes: Pythia6 tune A, AW, DW, DWT, D6, D6T.
- ATLAS: DC2, CSC/MC08, MC09, Mc09c.
- Perugia/Peter Skands tunes: S0, Perugia0, Perugia10 (soft, hard, no colour reconnection variants).

# Measuring the Underlying Event



# UE Measurements

- Many results from ATLAS and CMS.
- In busy LHC environments, how much of “UE” is UE?
- Sensitive to DPI contribution.
- Not just comparing with PS models, but with ME+PS setups too.

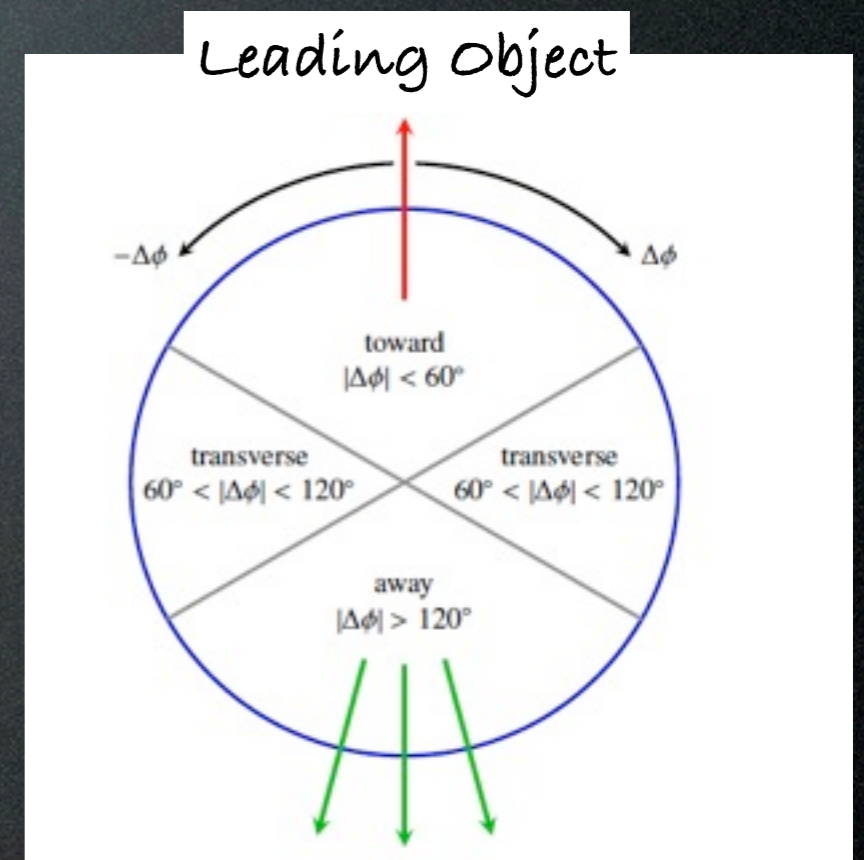

# Leading Jet and Z UE Results

Phys.Rev. D82 (2010) 034001

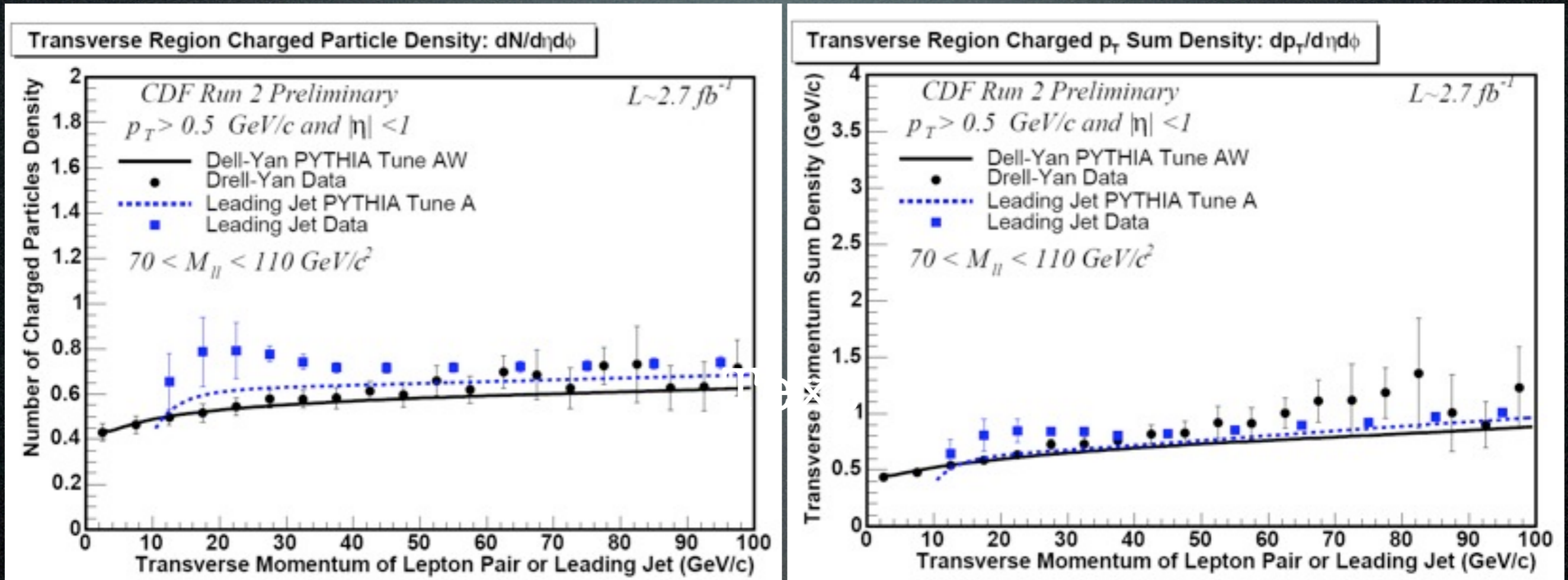

UE activity in Z-boson and jet events fairly similar in Tevatron.

**Is it still the case at the LHC?**

# Pre-LHC tunes

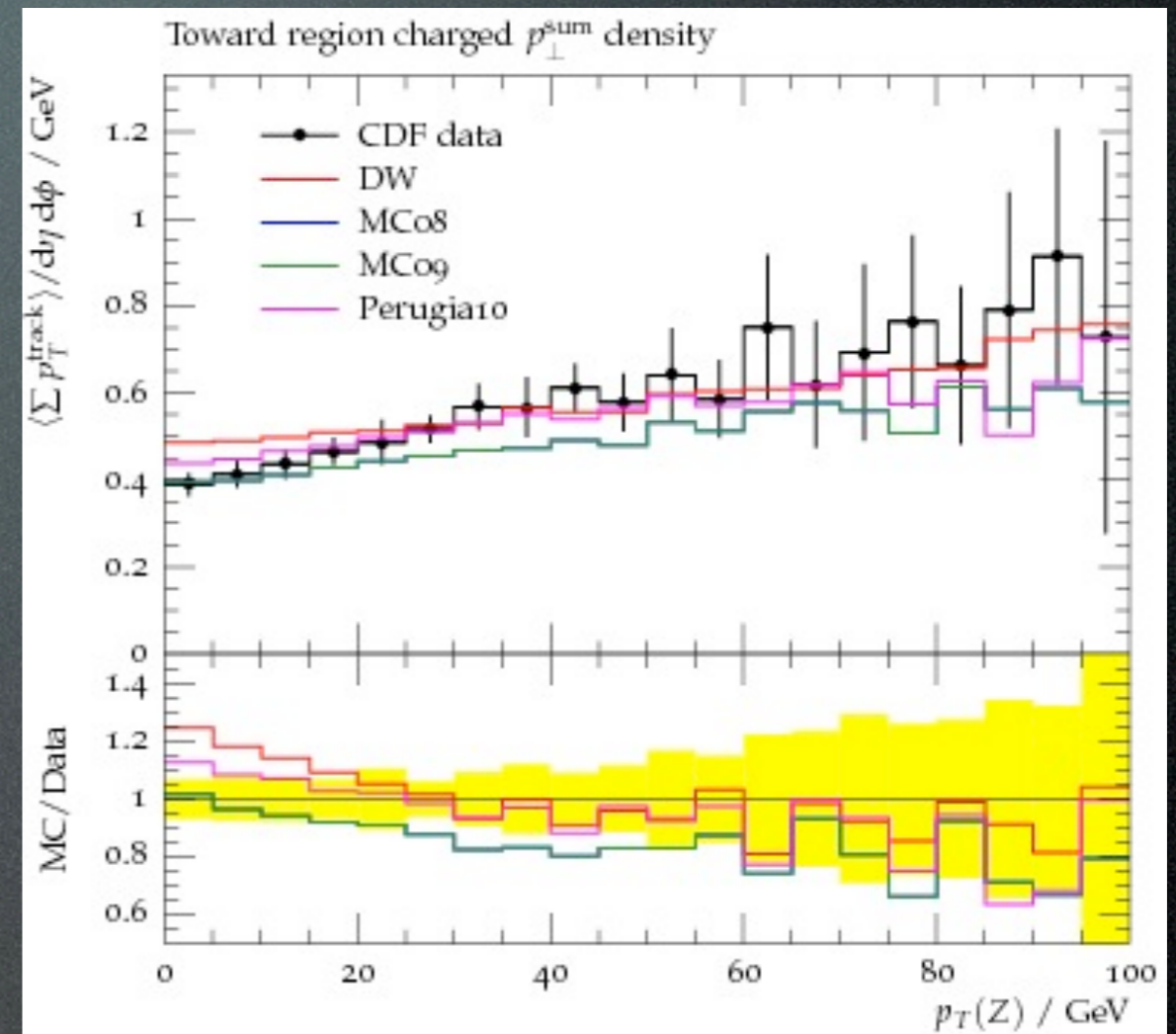
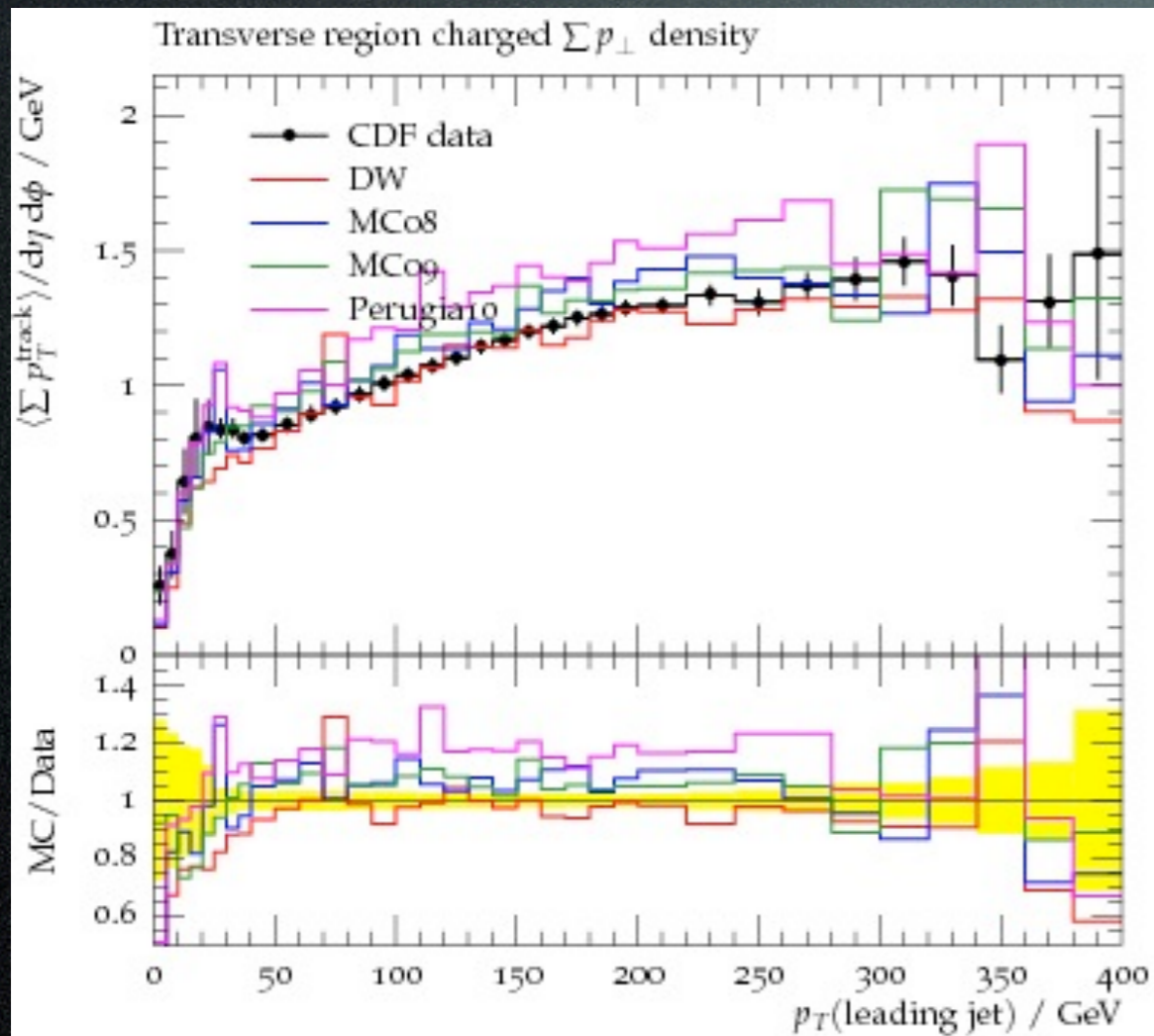

Phys.Rev. D82 (2010) 034001

The tunes do quite well ...

**Did they work at the LHC?**

# Then Came the LHC

- Tevatron tunes did not agree with the early minbias and underlying event data.
- Not just at 7 TeV, but also at 900 GeV!

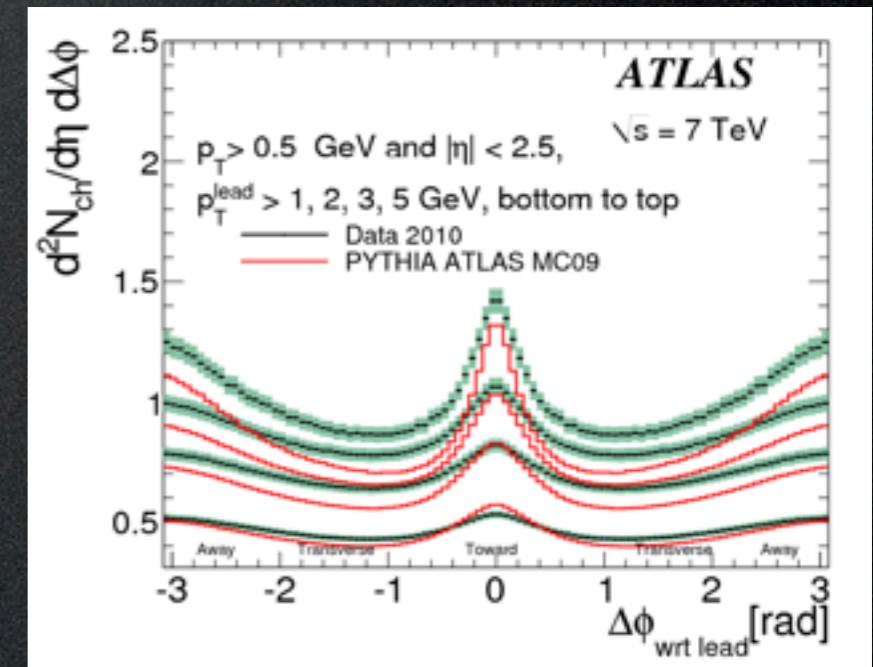
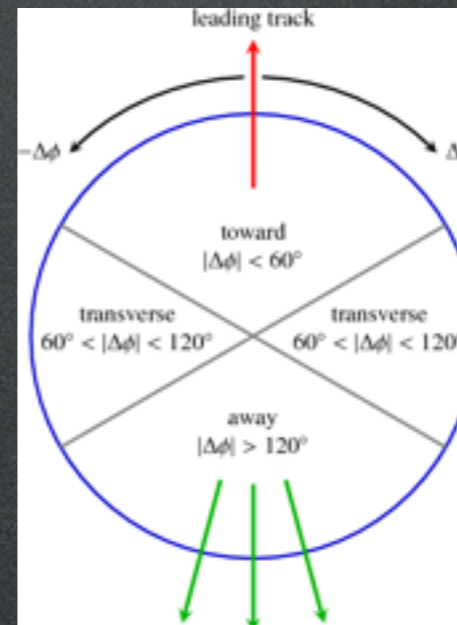
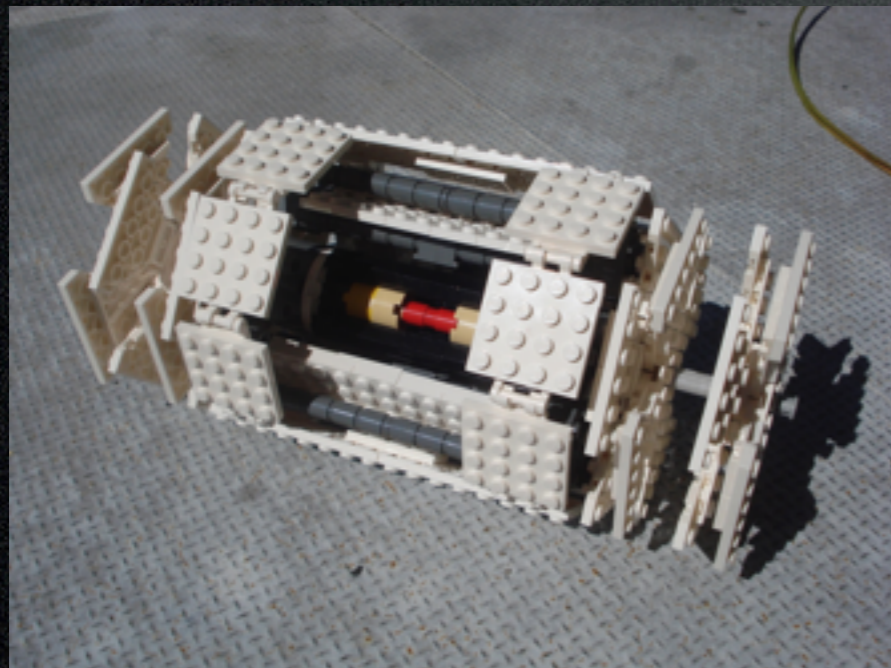
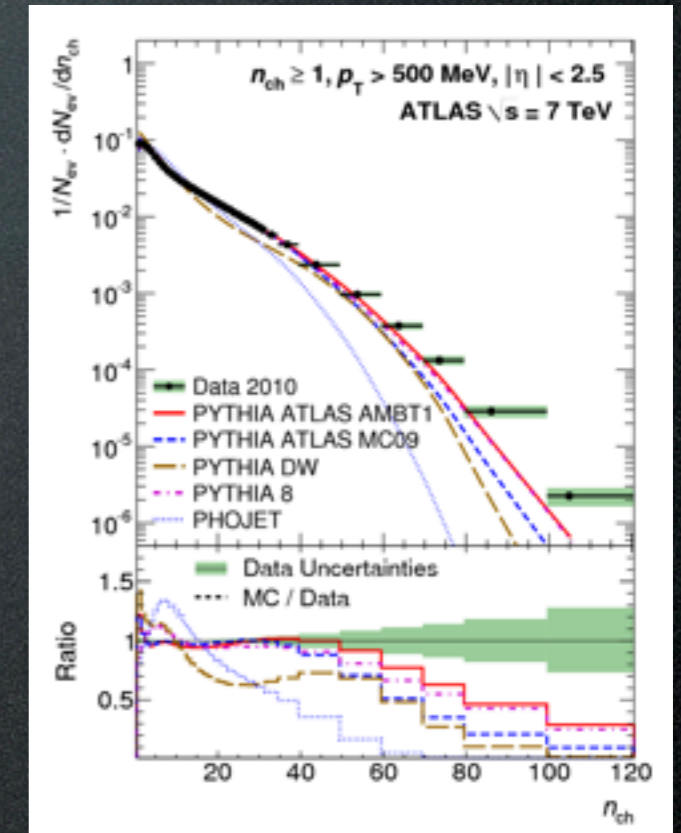
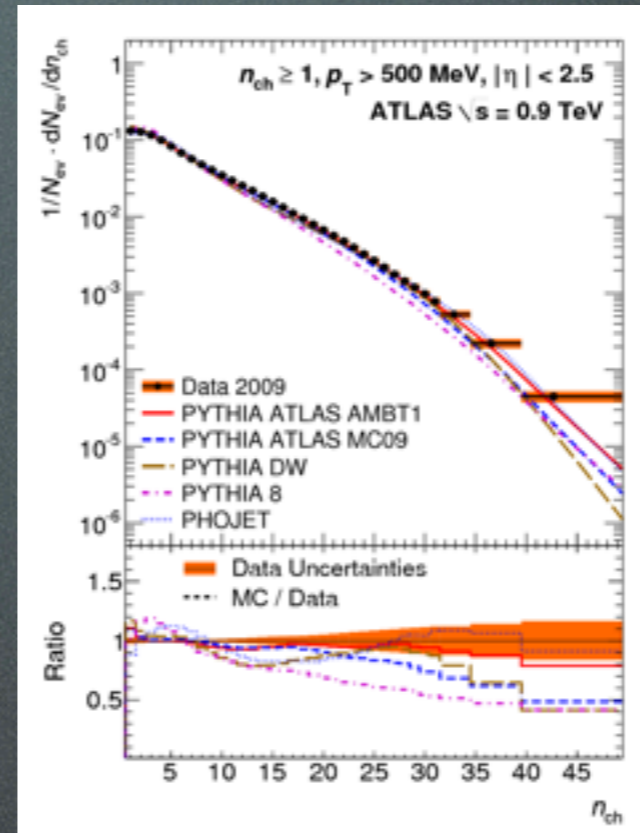

# A slight detour: comparison between UE and MB

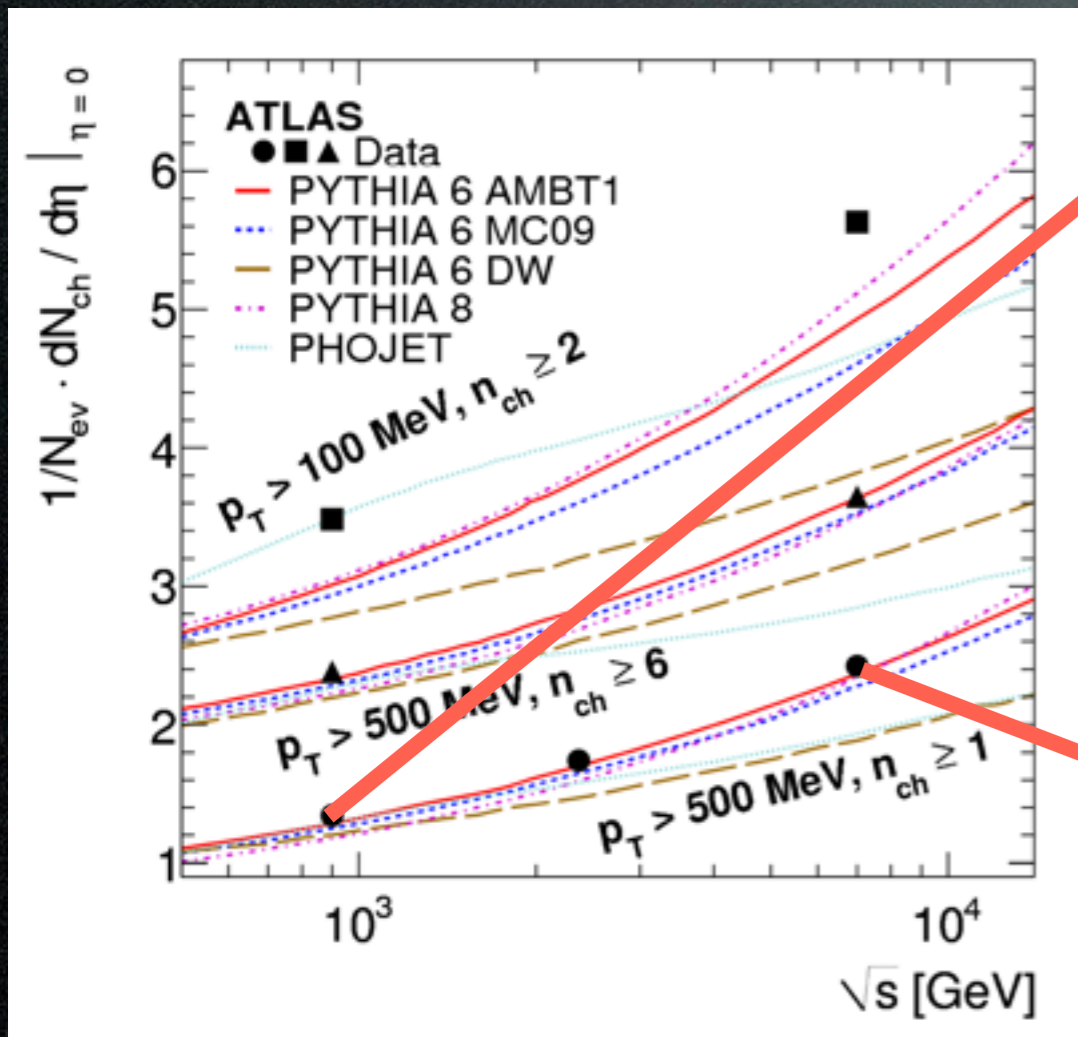

0.4 -> 2.5

~ 1.3

factor of 2!

0.8 -> 5

~ 2.4

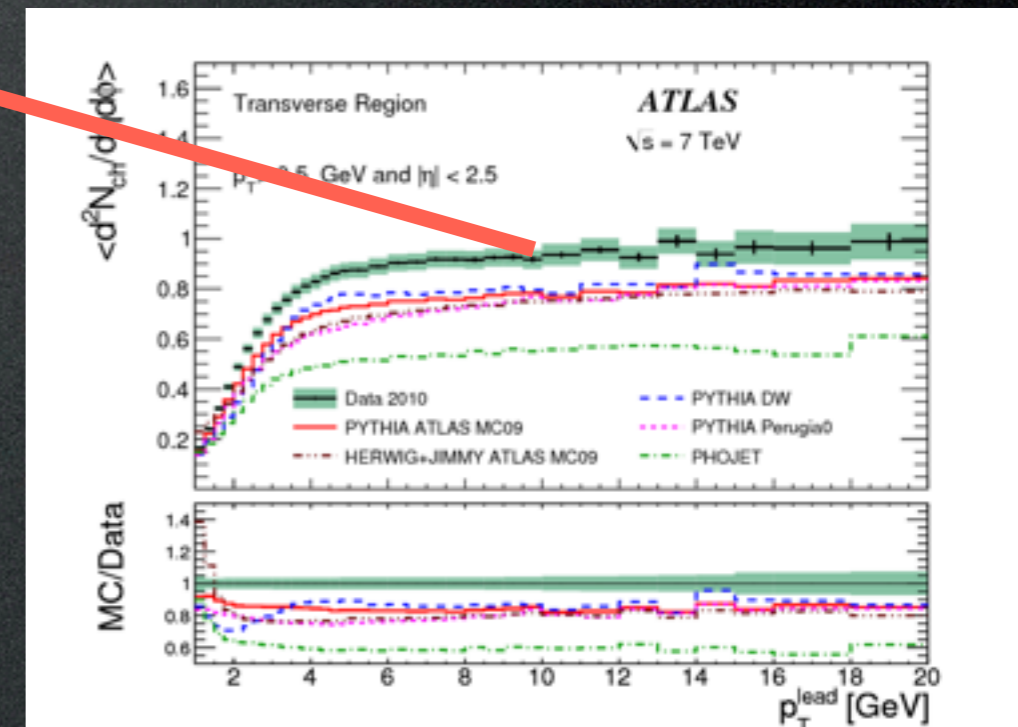
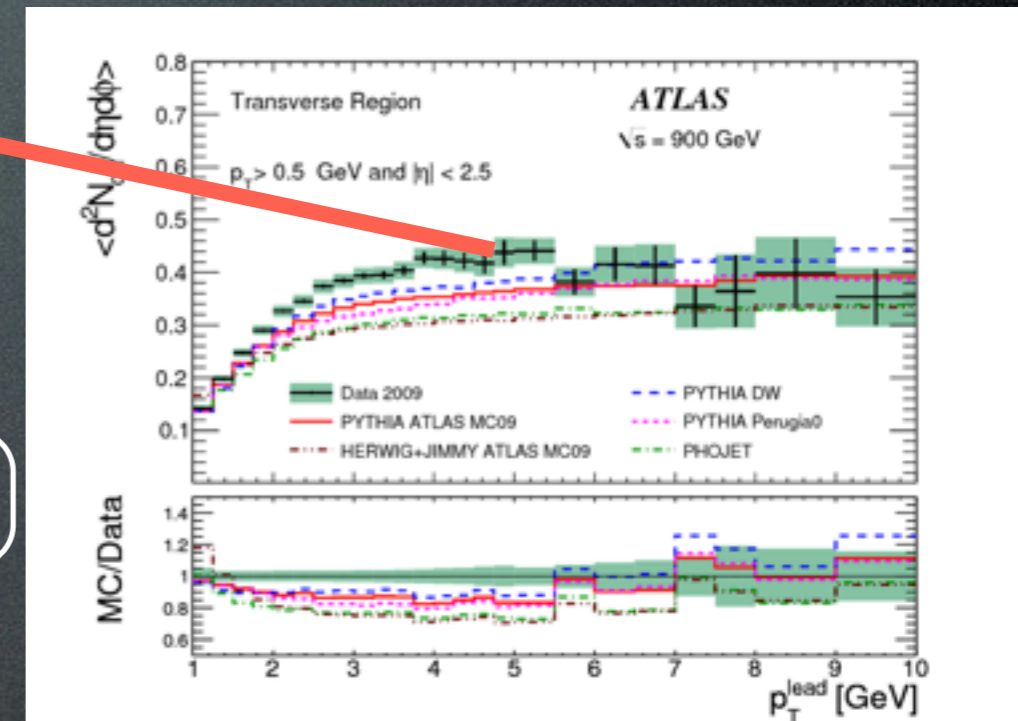

# Post-LHC Tunes

- (Pythia 6) ATLAS Tunes: AMBT1, AMBT2, AMBT2B, AUET2, AUET2B. [First separate MB/UE Tunes. also for many PDFs.]
- (Pythia 6) CMS Tunes: Z1, Z2, Z2\*.
- (Pythia 6) Perugia 2011 tunes.
- (Pythia 8) author tunes: 4C, 4Cx.
- (Pythia 8) ATLAS tunes: A2, AU2, A14.



# How do they do?

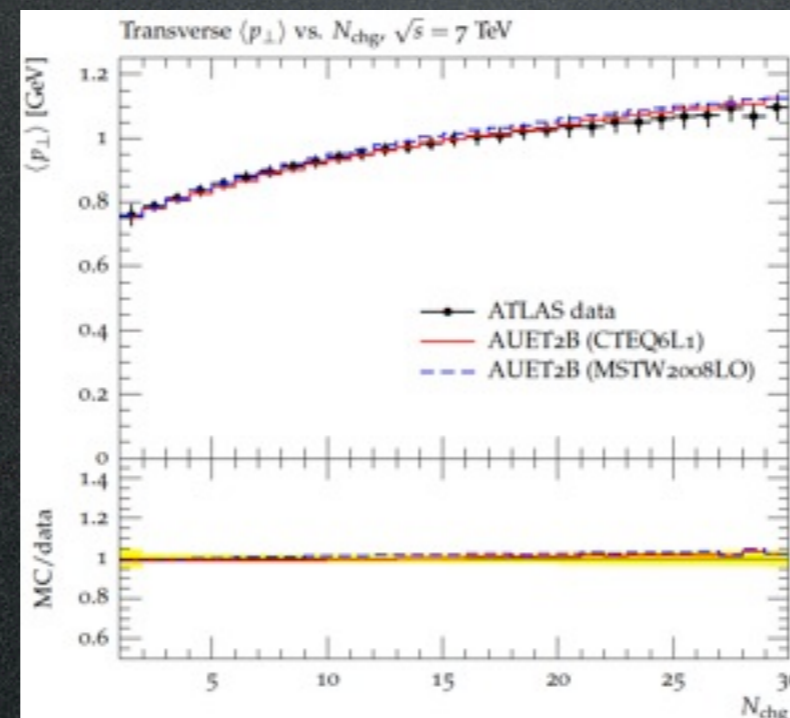
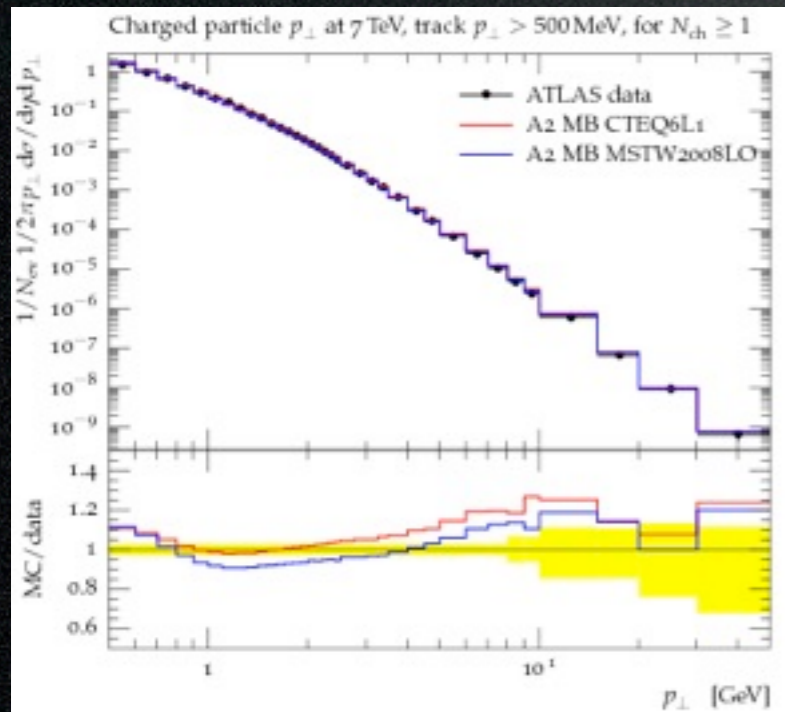
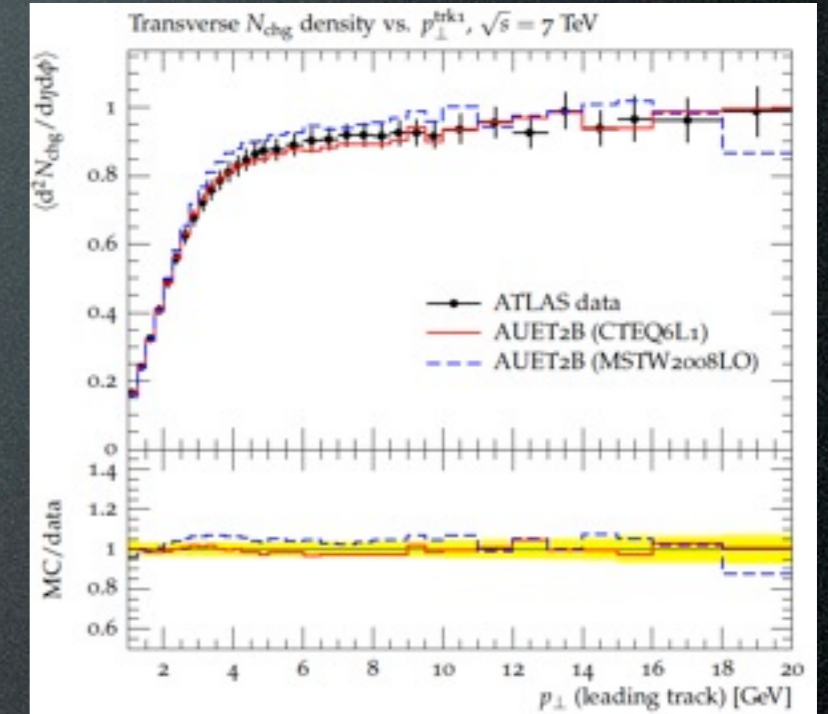
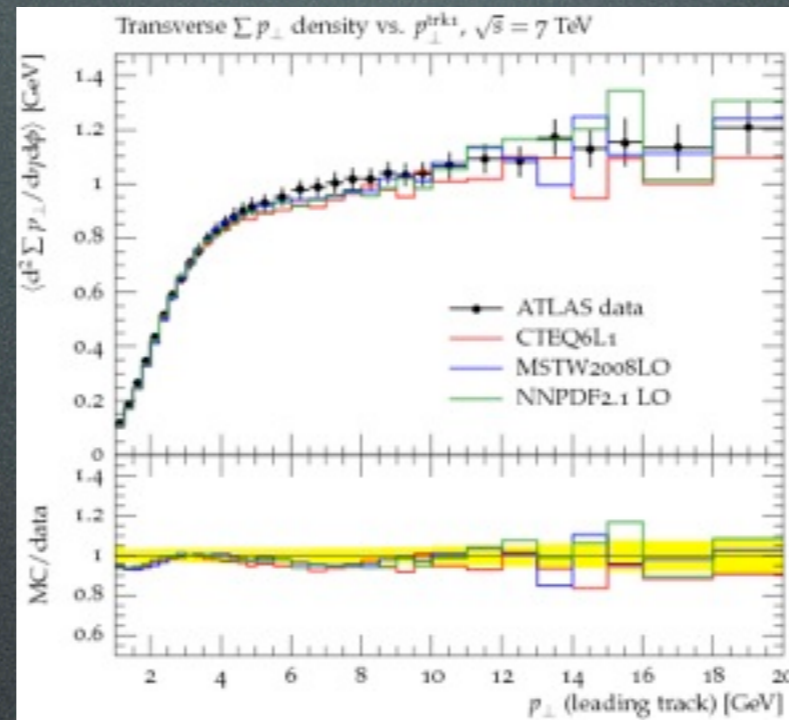
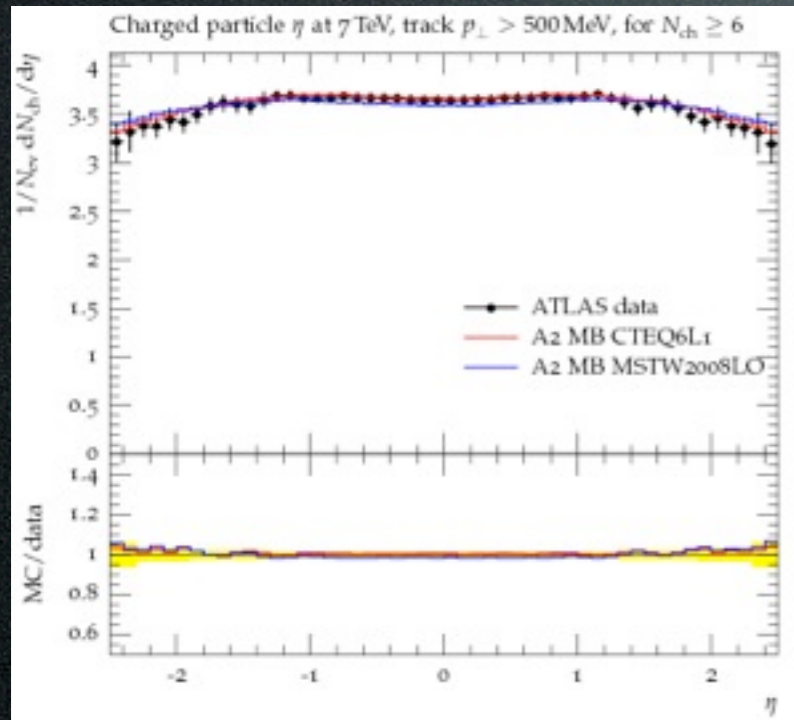

How good is good?

# How do they do?

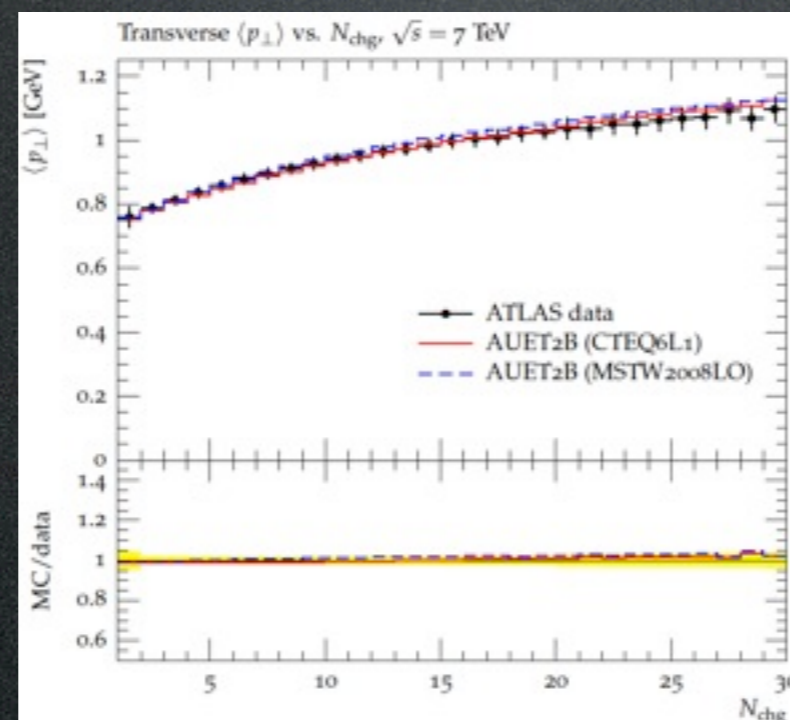
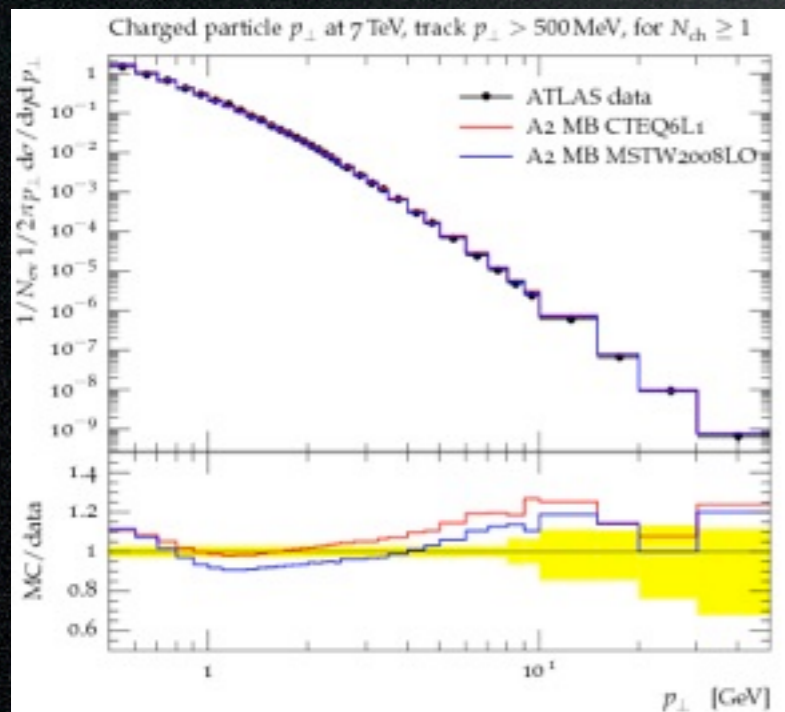
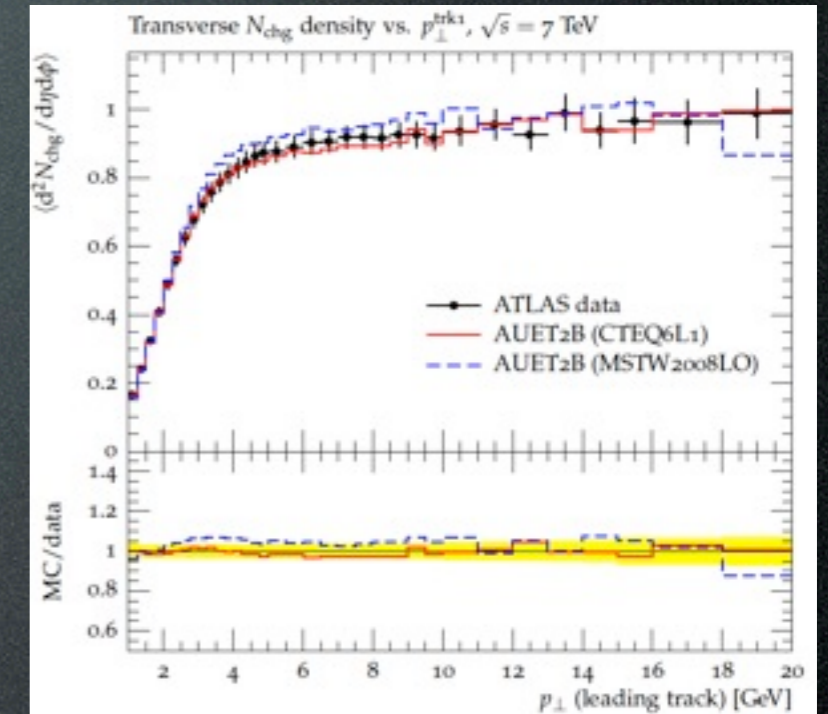
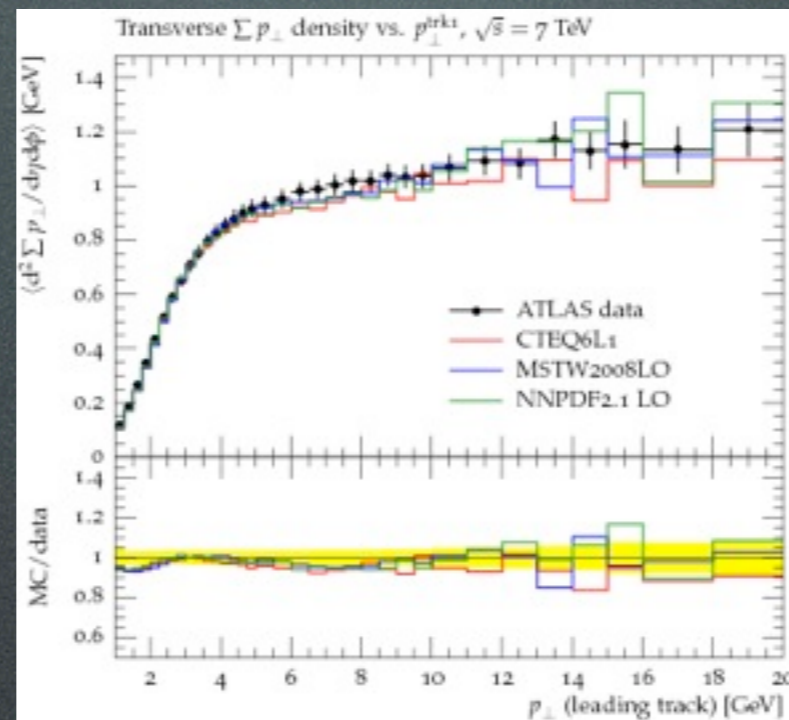
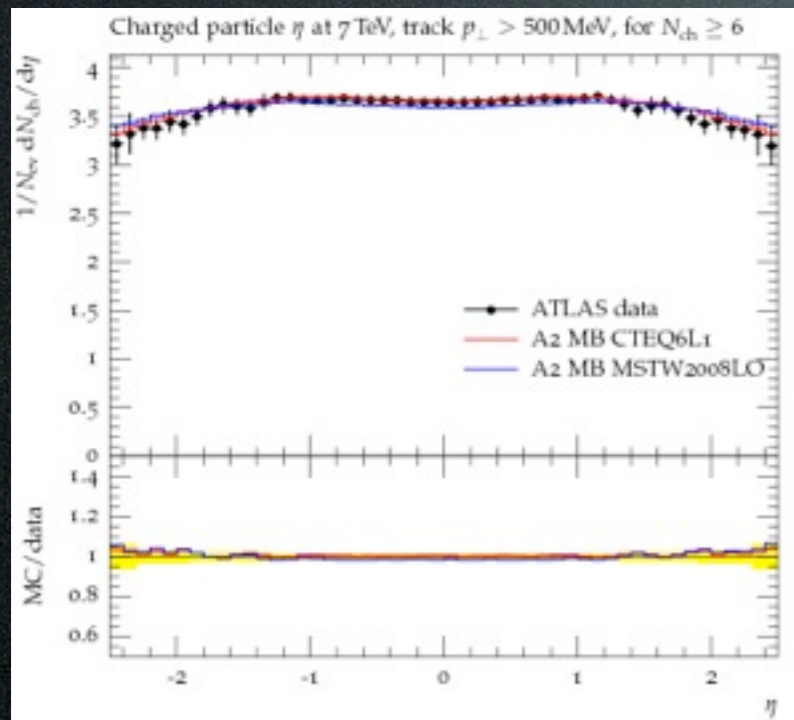

How good is good?  
Is not it amazing that  
the models are doing  
so well?

# Back to (early) UE Results

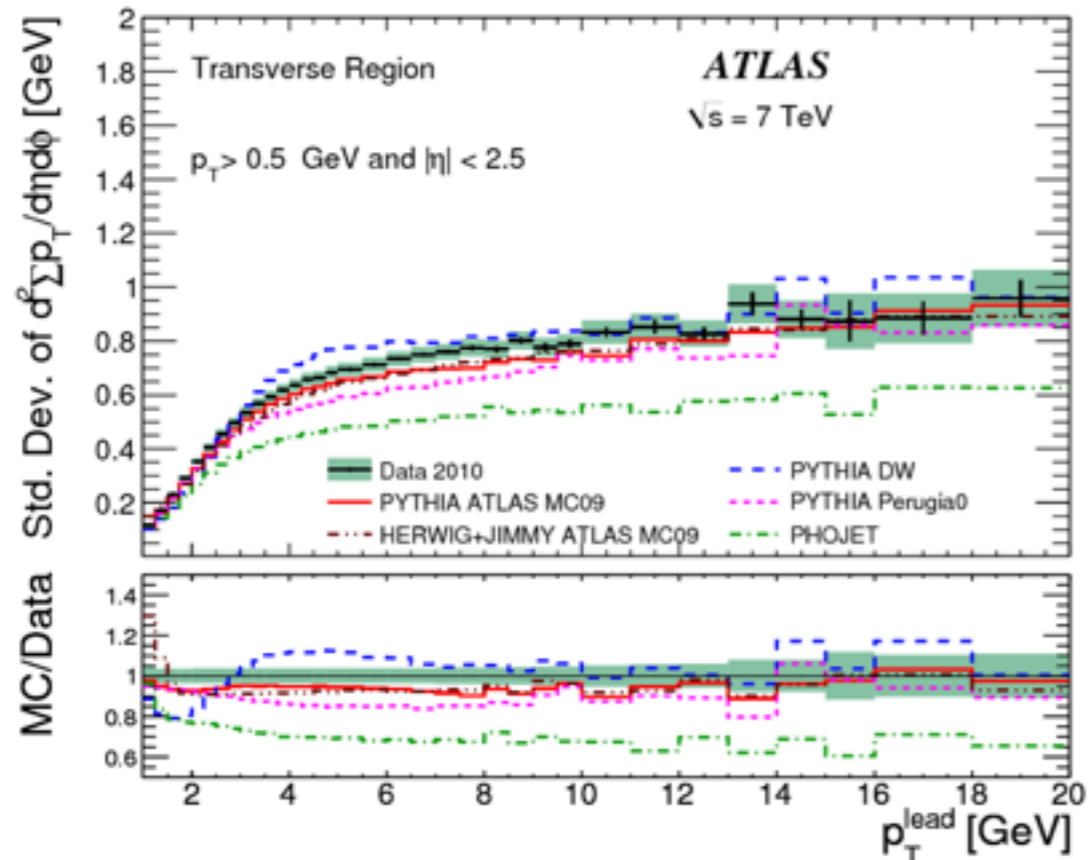

shows UE activity can not be subtracted as an average “pedestal” from each event.

Sensitive to both charged and neutral component of UE.

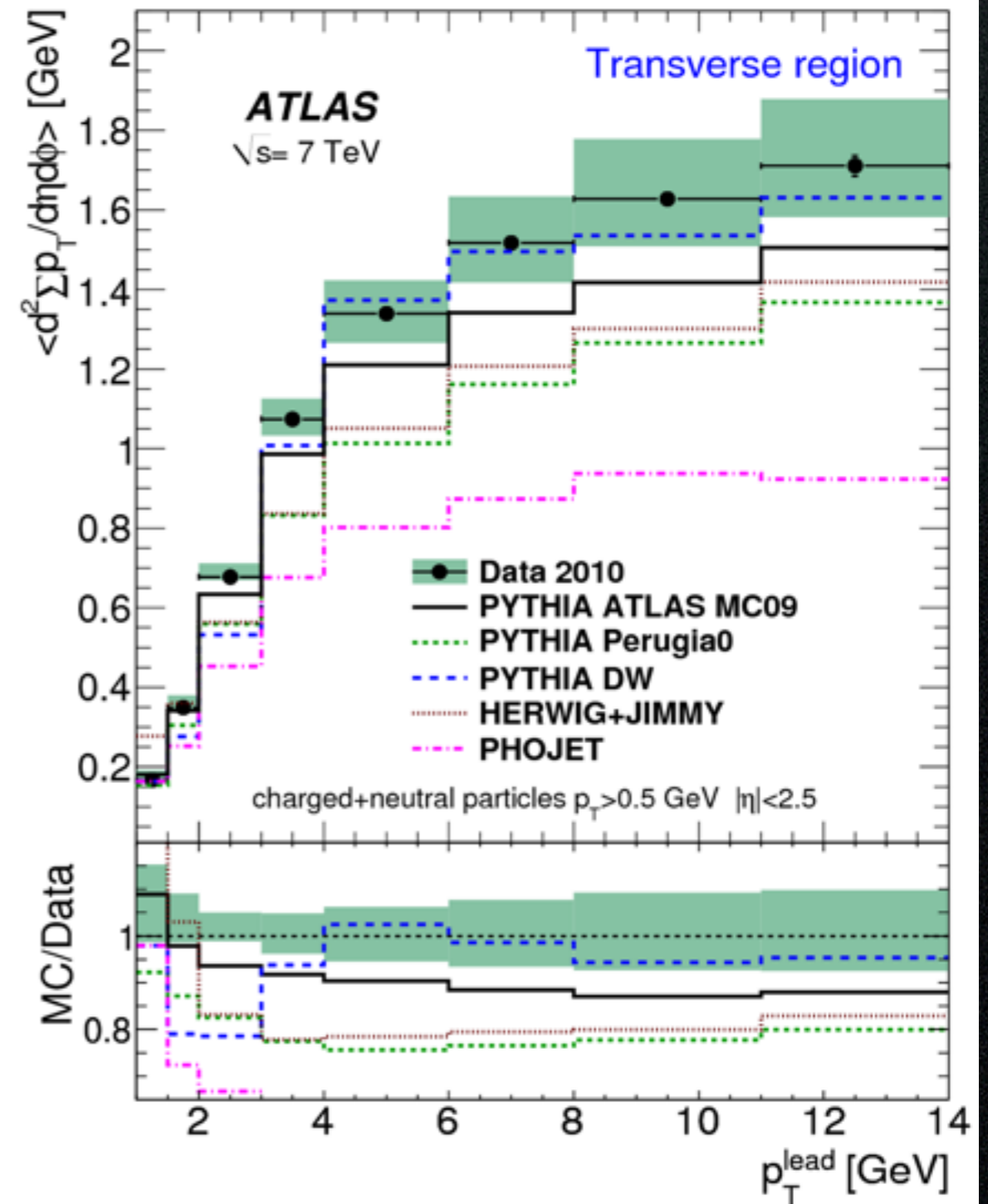

# LPCC UE&MB WG

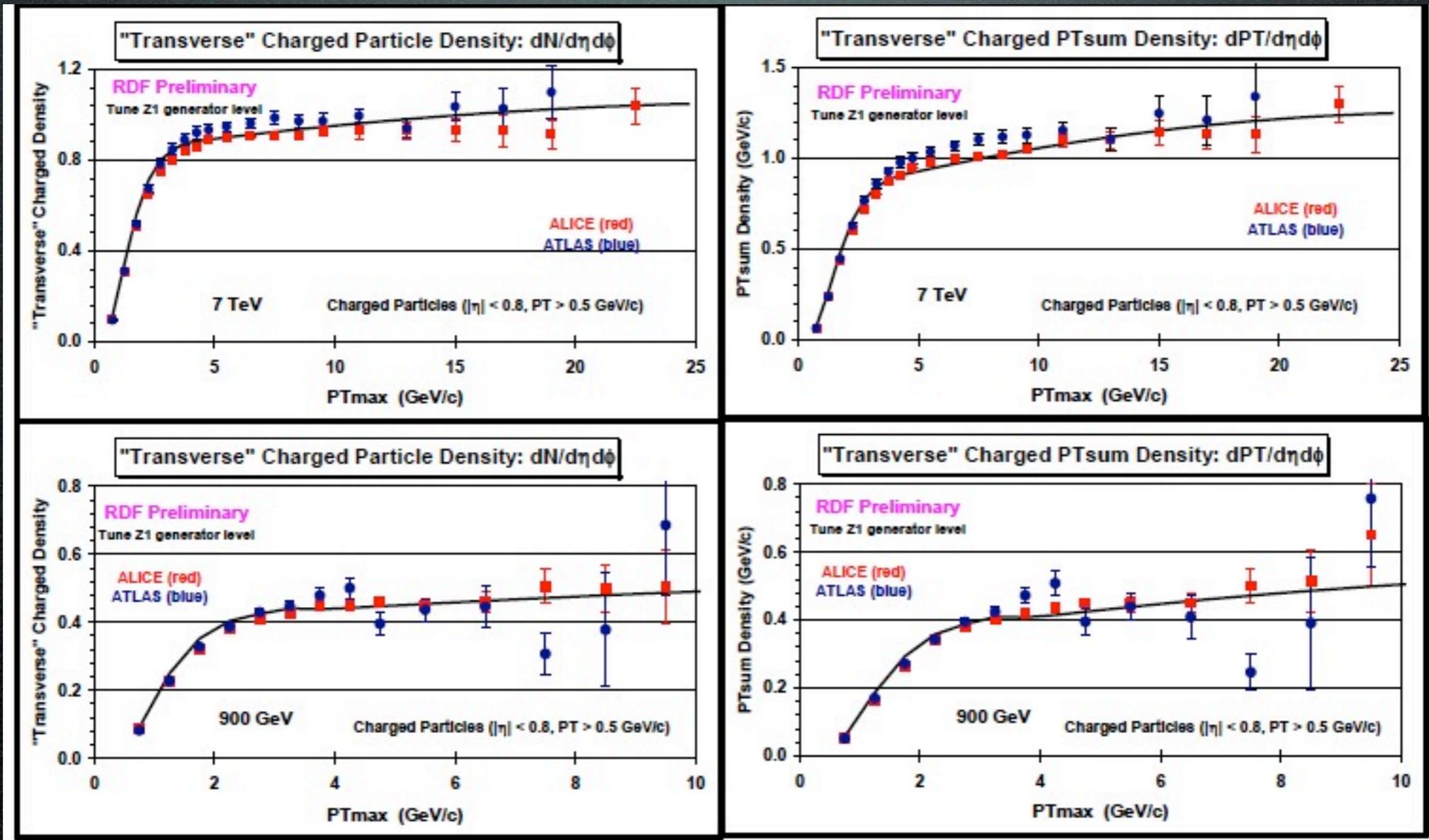

Rick Field: WG meeting, 17th June 2011

# Jet Radius Dependence

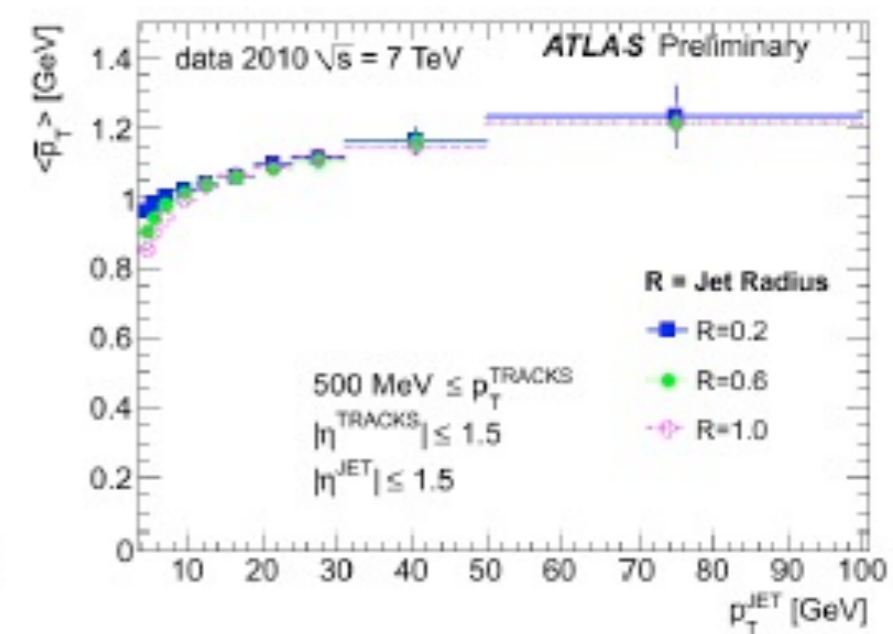
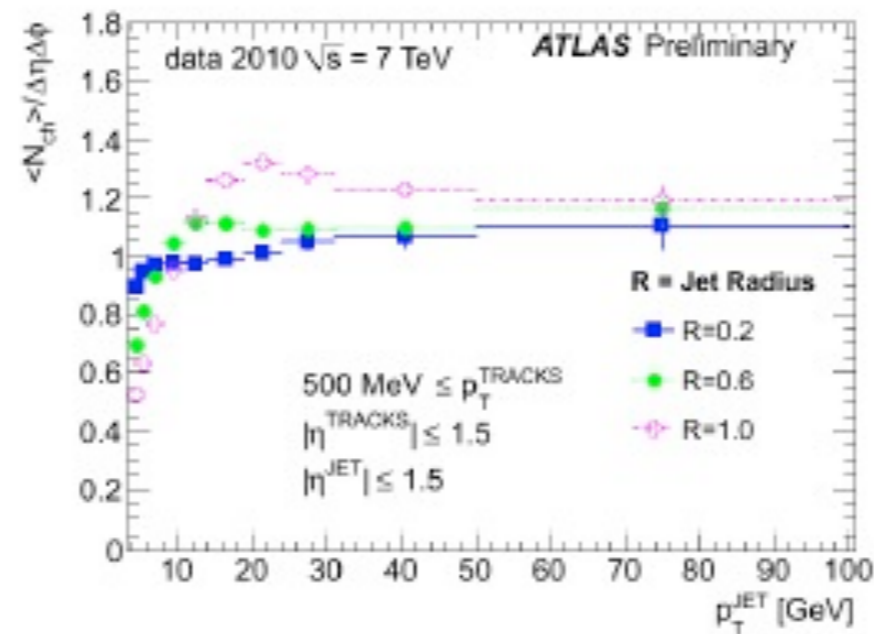
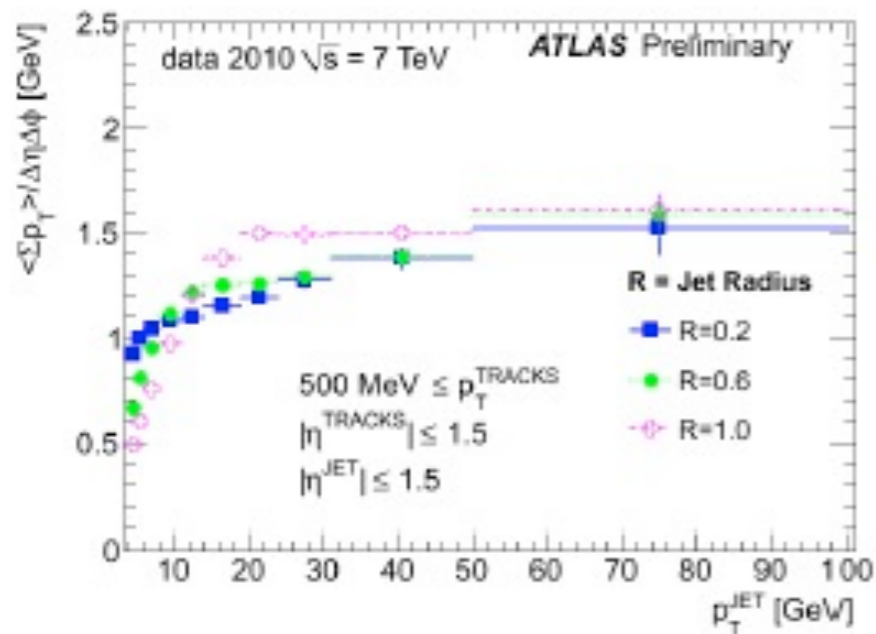

More UE activity for higher jet radius.  
Why?

# ATLAS Jet UE

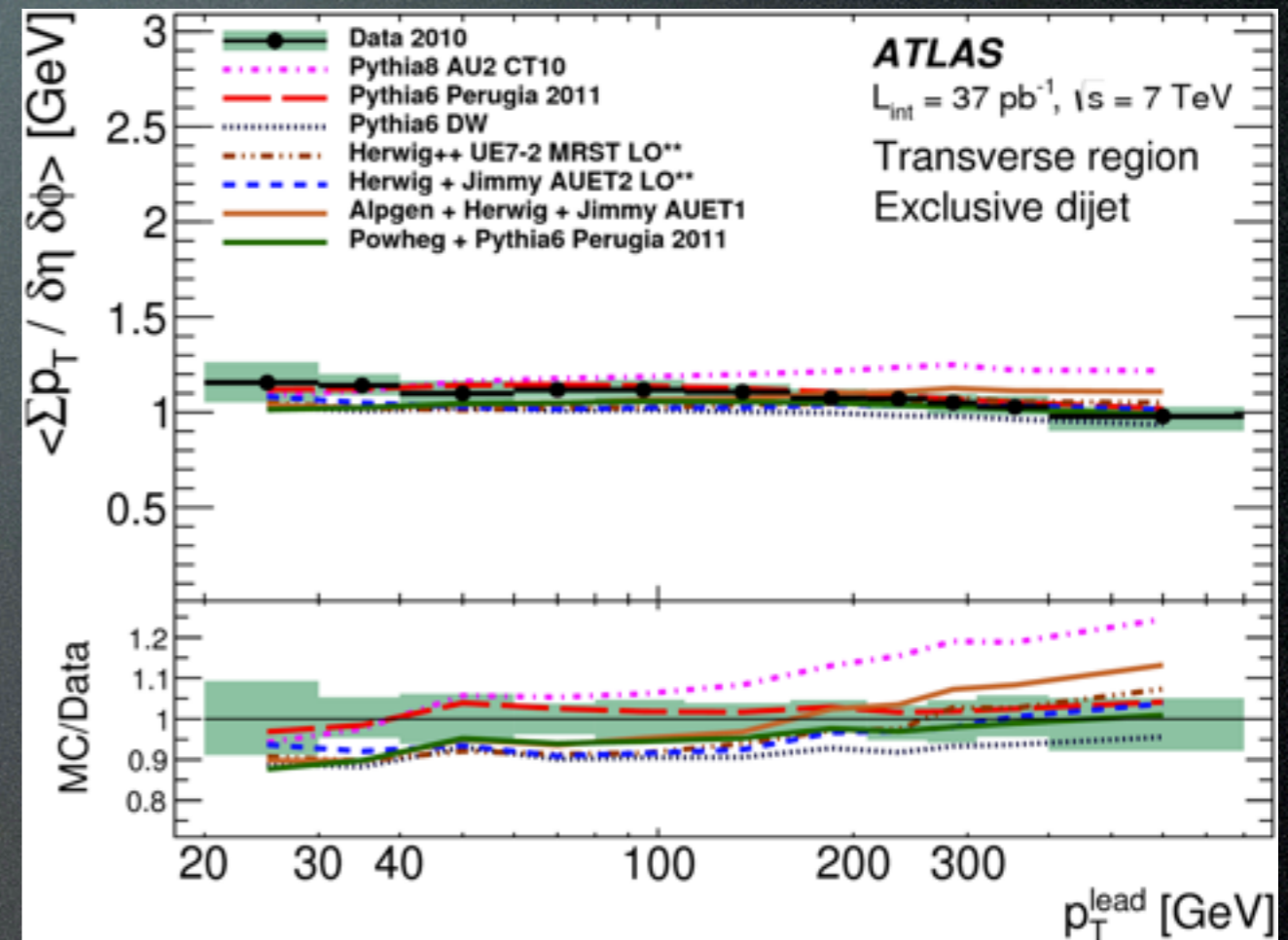
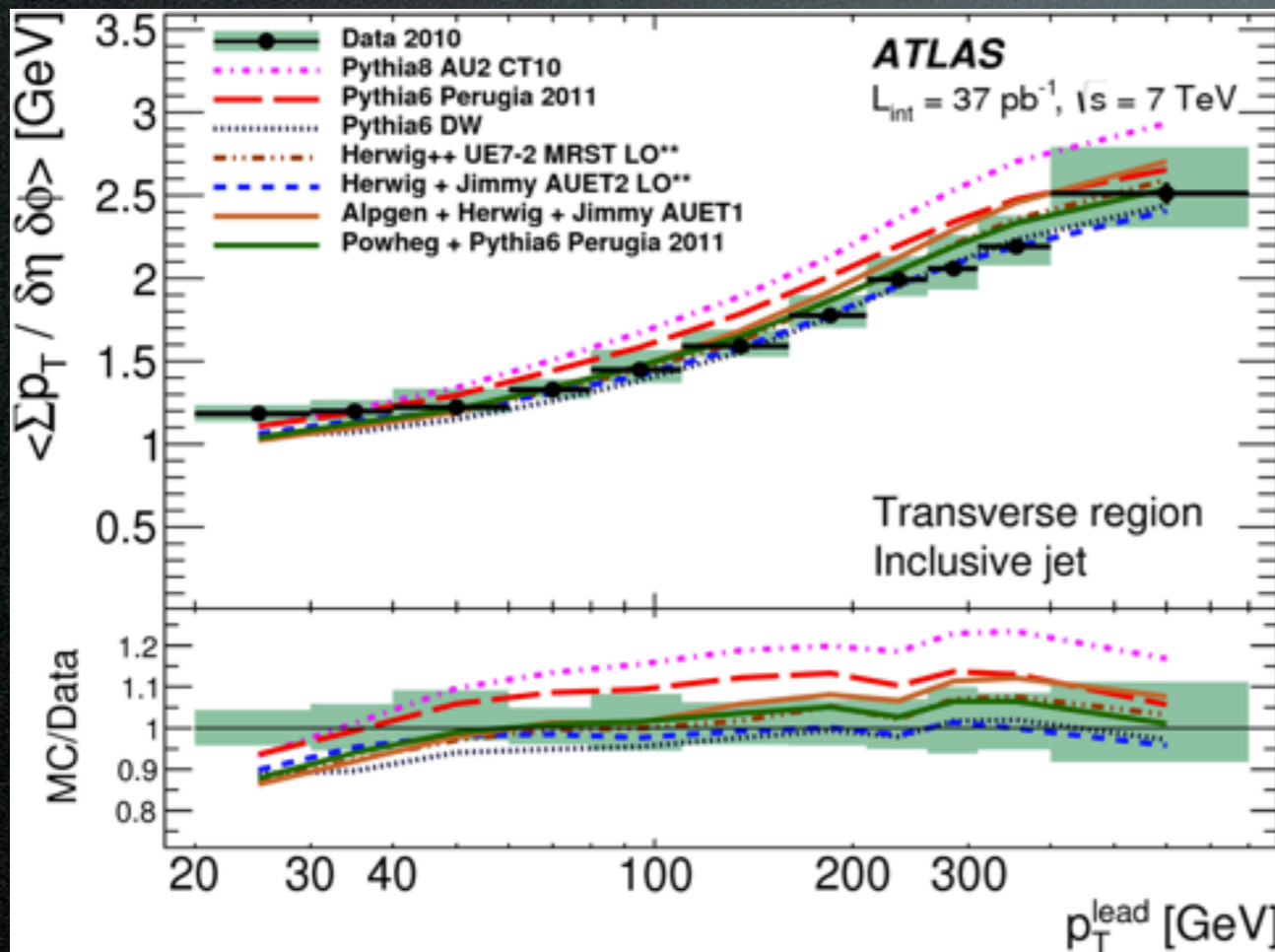

Rise in inclusive, almost flat in when requiring exactly 2 jets .  
 Models better describe exclusive profile.

# ATLAS Z UE

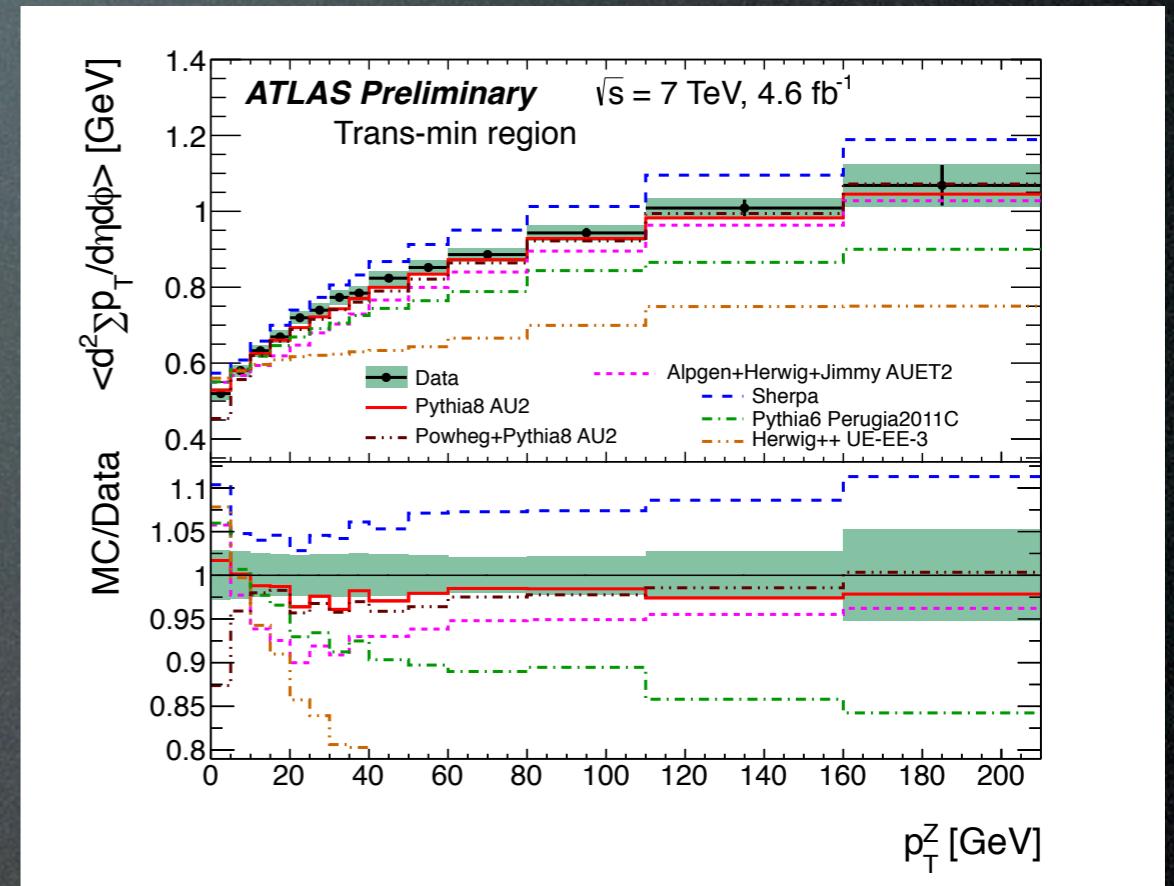
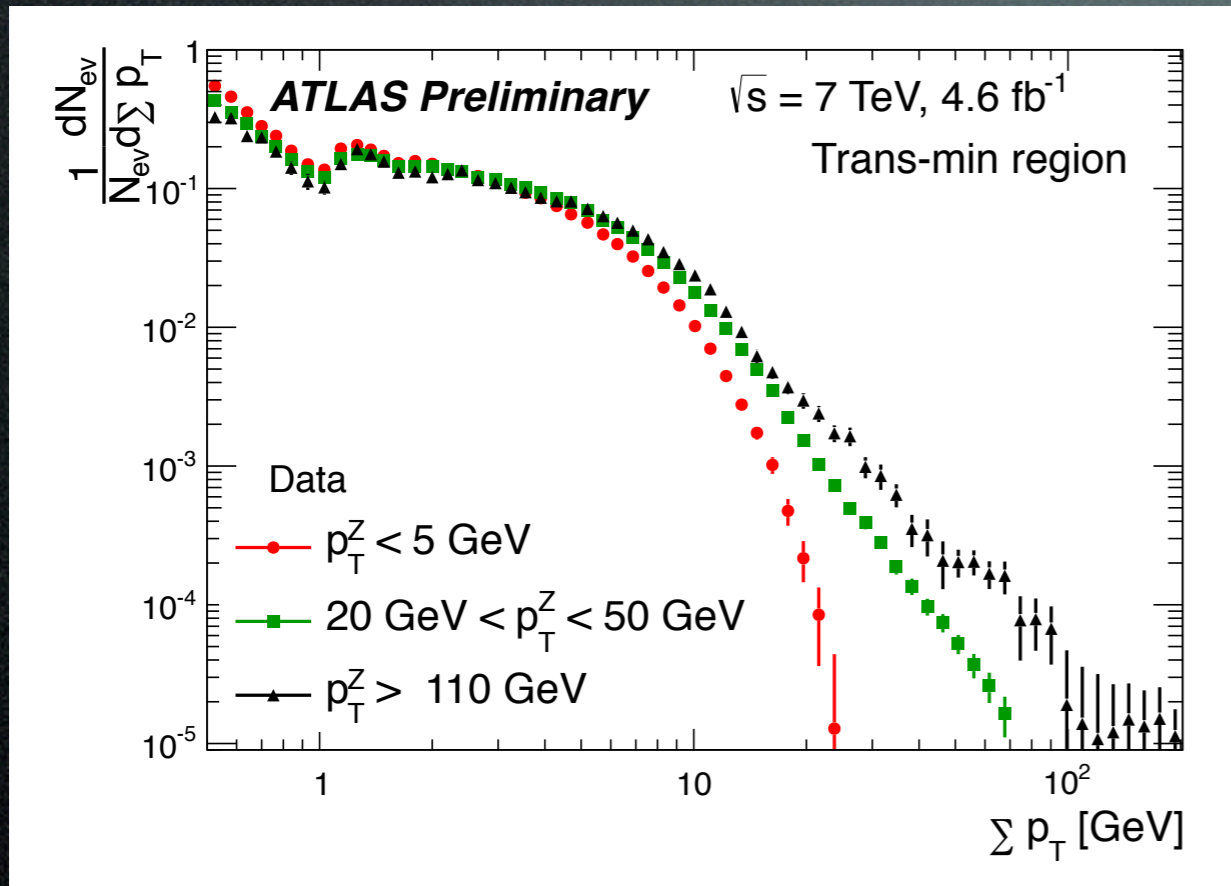

Transmin independent of Z  $p_T$  till about 10 GeV, profile best described by Pythia8 and Powheg+Pythia8

However full transverse (or trans-max) regions are described better by NLO or multileg generators than pure LO ones.

# Z/Jet UE Comparison

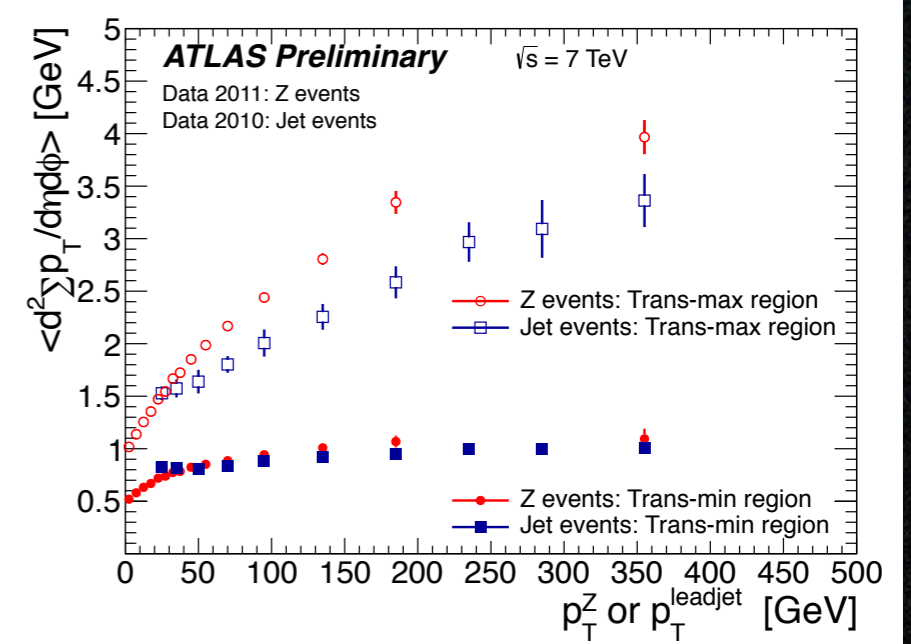
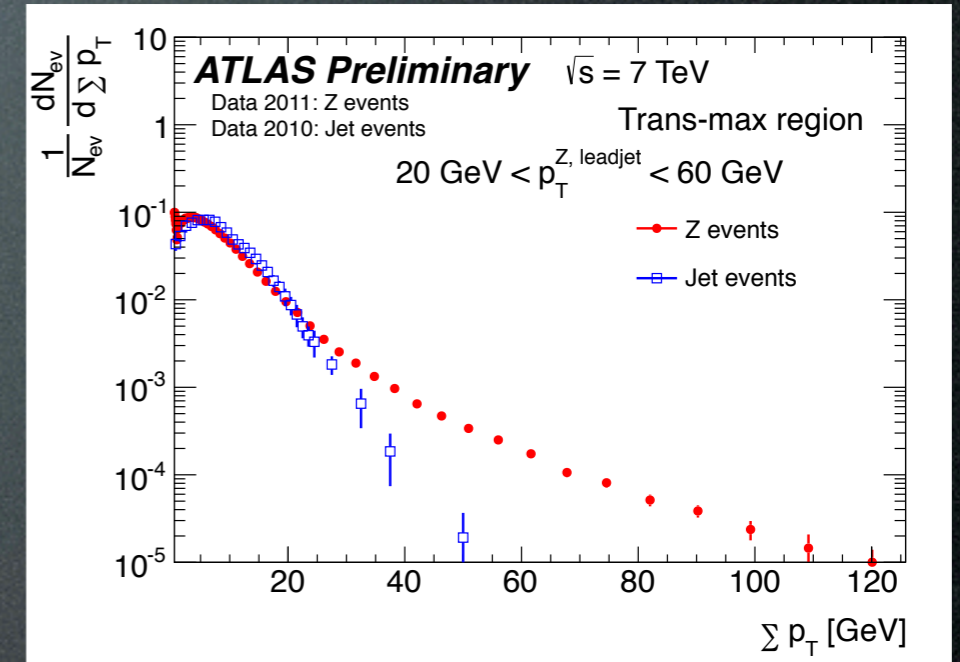
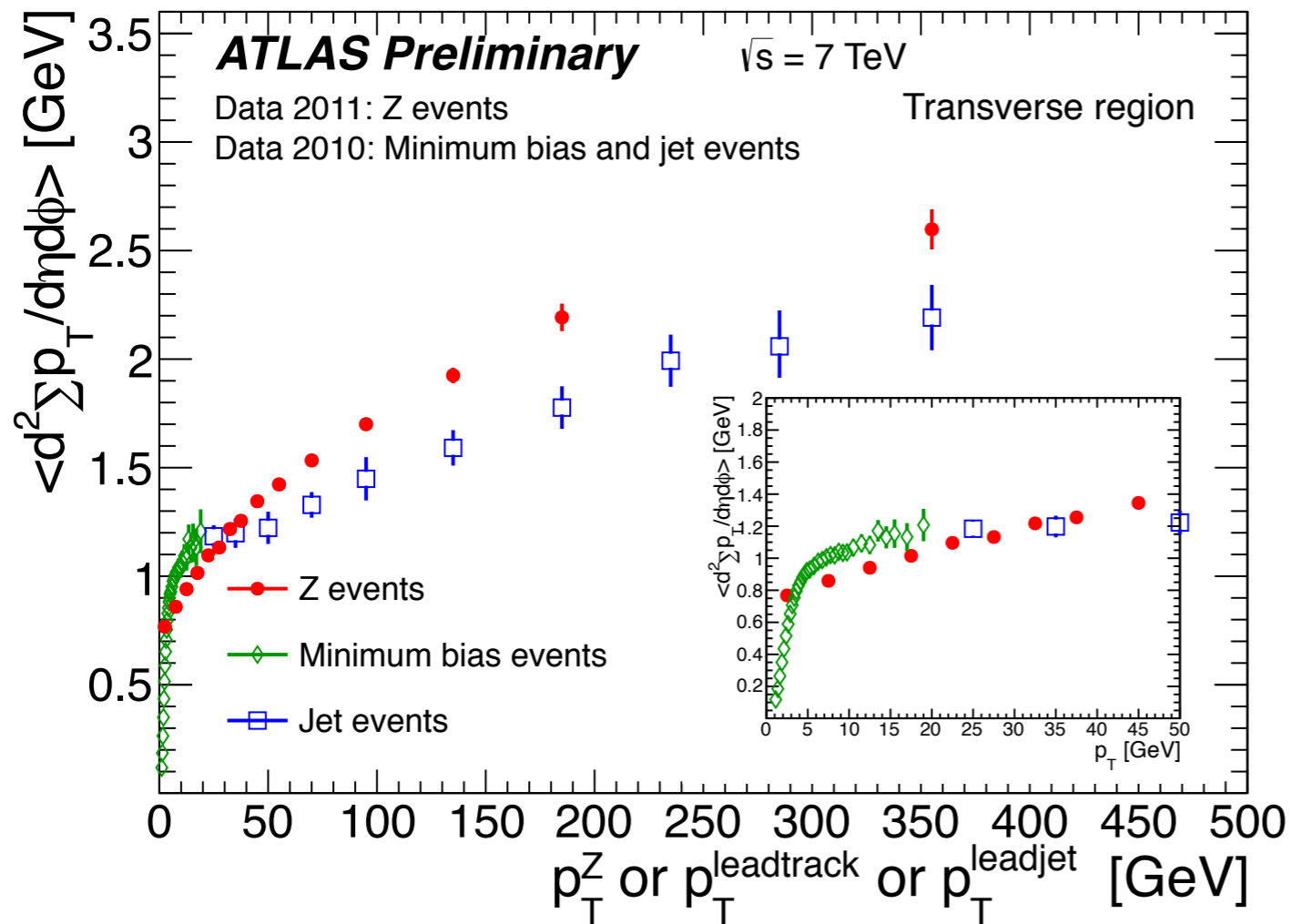

Discrepancy due to selection bias,  
 trans-min identical.



# Isolating the UE

- Full transverse (or trans-max) regions are described better by NLO or multileg generators than pure LO ones.
- Trans-min (and towards region for Z-boson events) were thought to be populated by “pure” UE.
- But at LHC, even those are not flat.

# Tuning Shower & MPI Together

Parameter	Definition
<code>SigmaProcess:alphaSvalue</code>	The $\alpha_S$ value at scale $Q^2 = M_Z^2$
<code>SpaceShower:pT0Ref</code>	ISR $p_T$ cutoff
<code>SpaceShower:pTmaxFudge</code>	Mult. factor on max ISR evolution scale
<code>SpaceShower:pTdampFudge</code>	Factorisation/renorm scale damping
<code>SpaceShower:alphaSvalue</code>	ISR $\alpha_S$
<code>TimeShower:alphaSvalue</code>	FSR $\alpha_S$
<code>BeamRemnants:primordialkThard</code>	Hard interaction primordial $k_{\perp}$
<code>MultipartonInteractions:pT0Ref</code>	MPI $p_T$ cutoff
<code>MultipartonInteractions:alphaSvalue</code>	MPI $\alpha_S$
<code>BeamRemnants:reconnectRange</code>	CR strength

Used exponential matter overlap

Also:

`MultipartonInteractions:ecmPow`

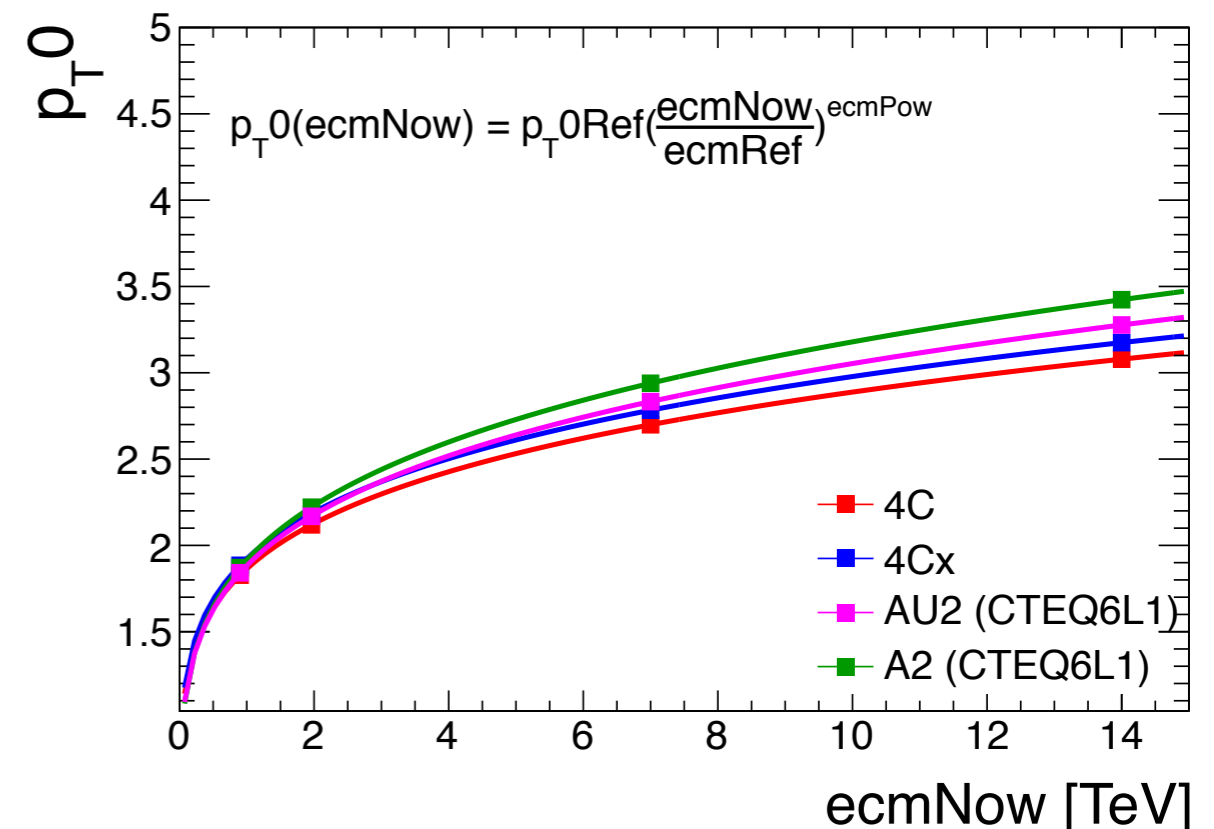

# Tuning Shower & MPI Together

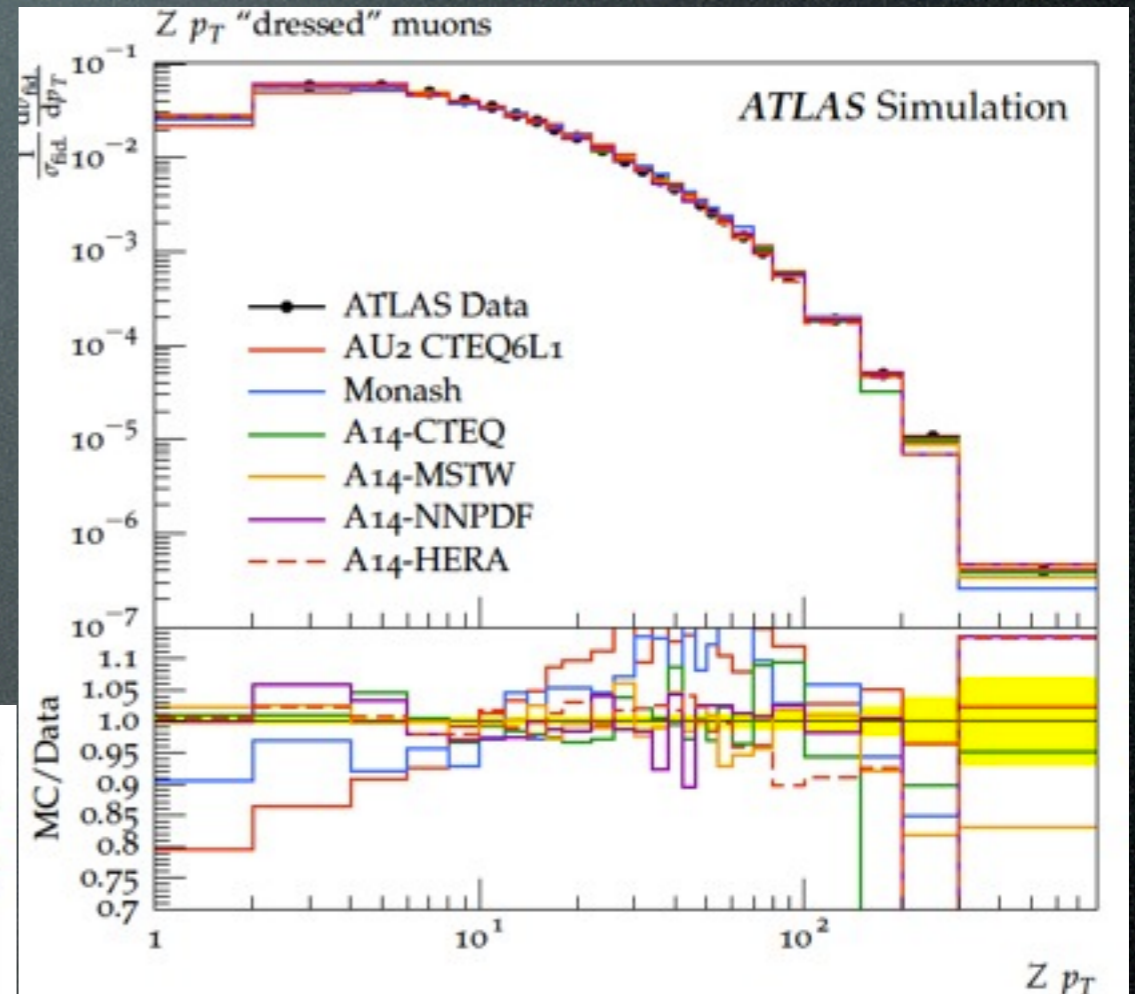
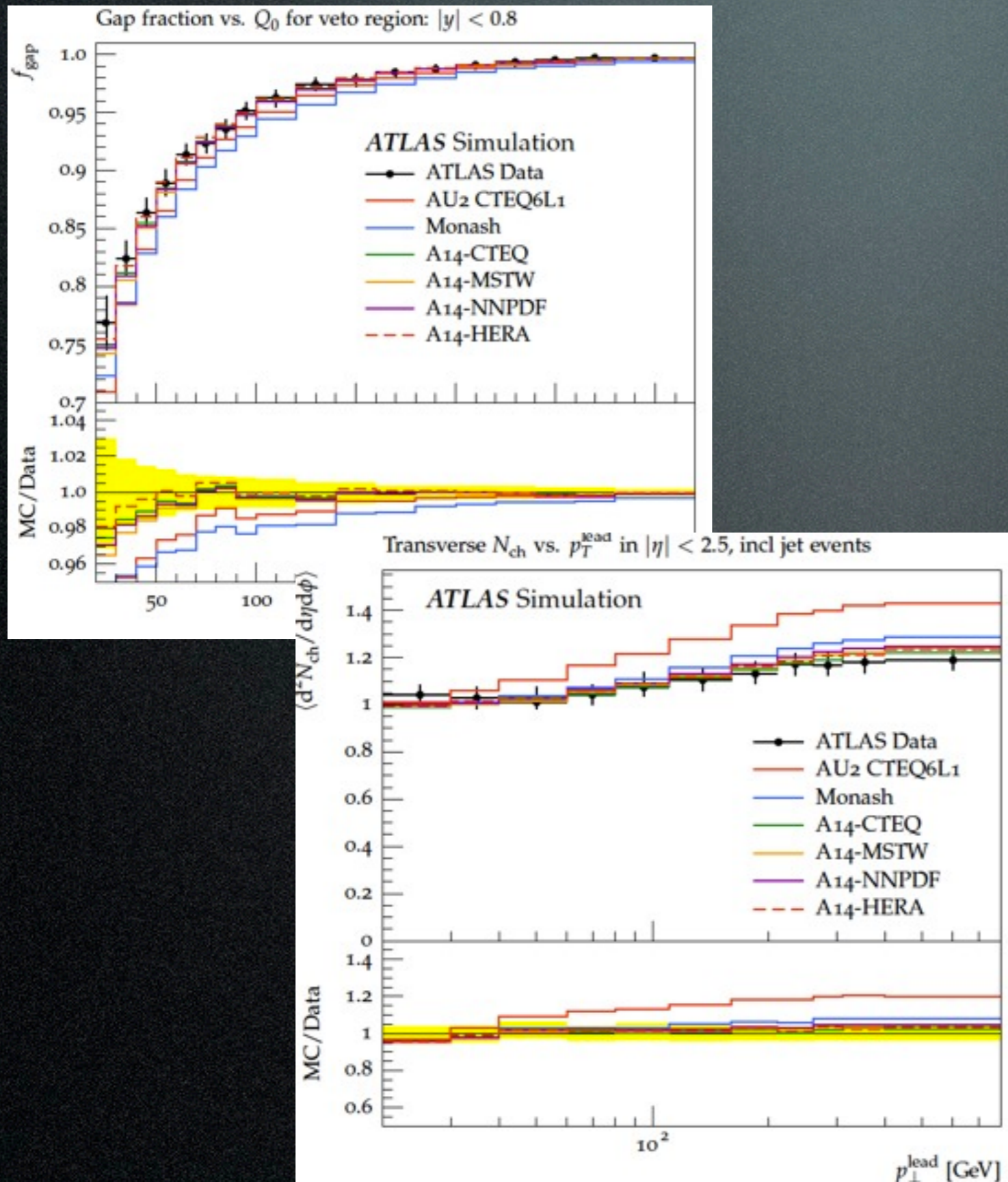

New A14 tune!  
(with systematic variation  
tunes)

Extend to matched  
setups...

# UE-sensitive Observables

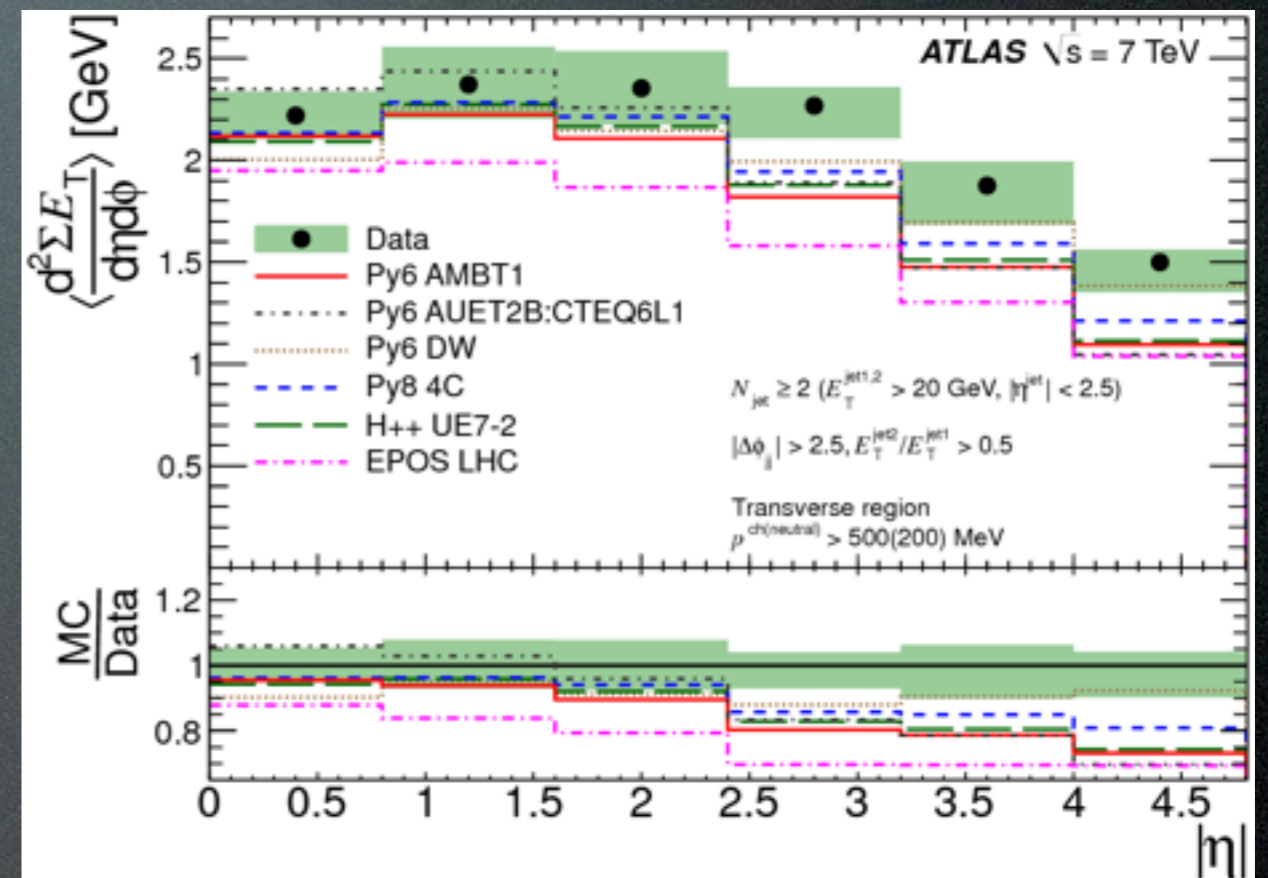
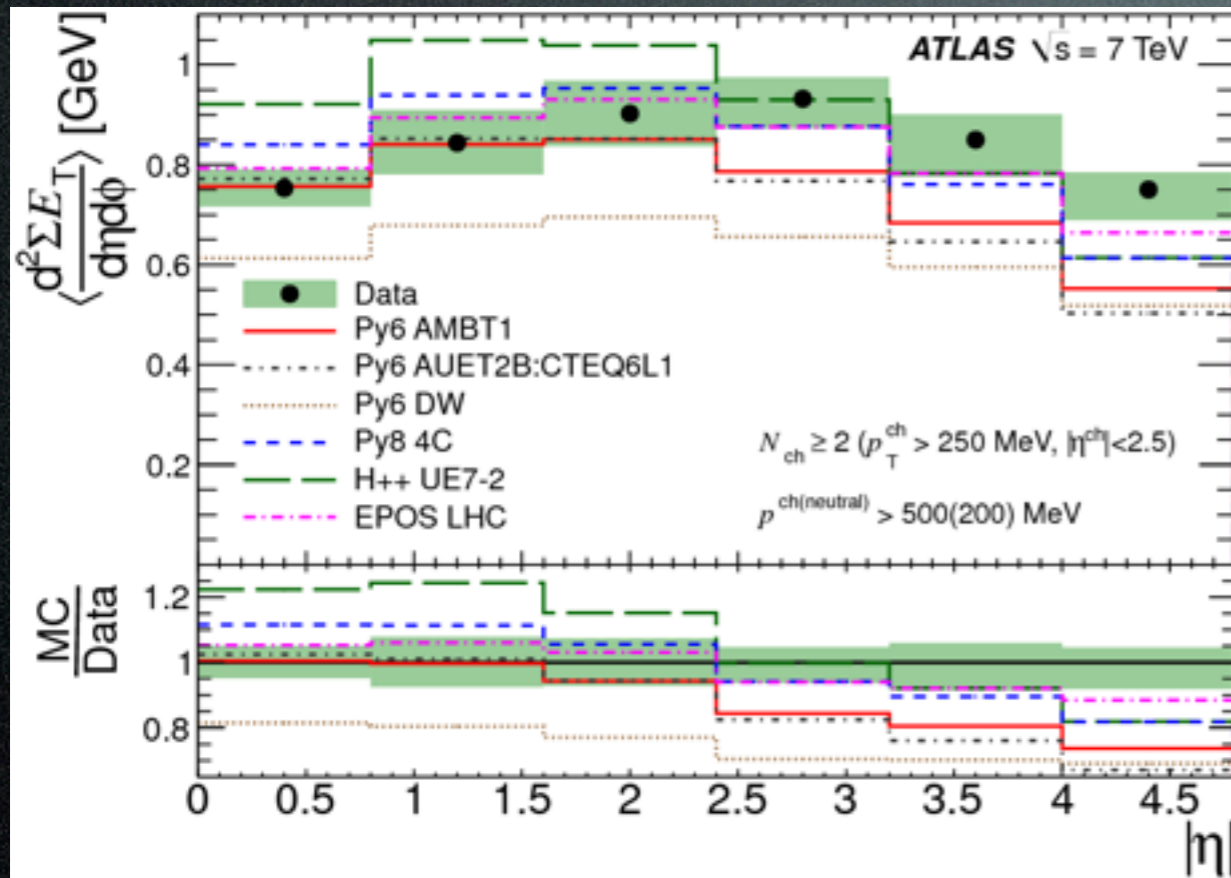

JHEP11 (2012) 033

Transverse energy flow: all models bad in forward region

# UE-sensitive Observables

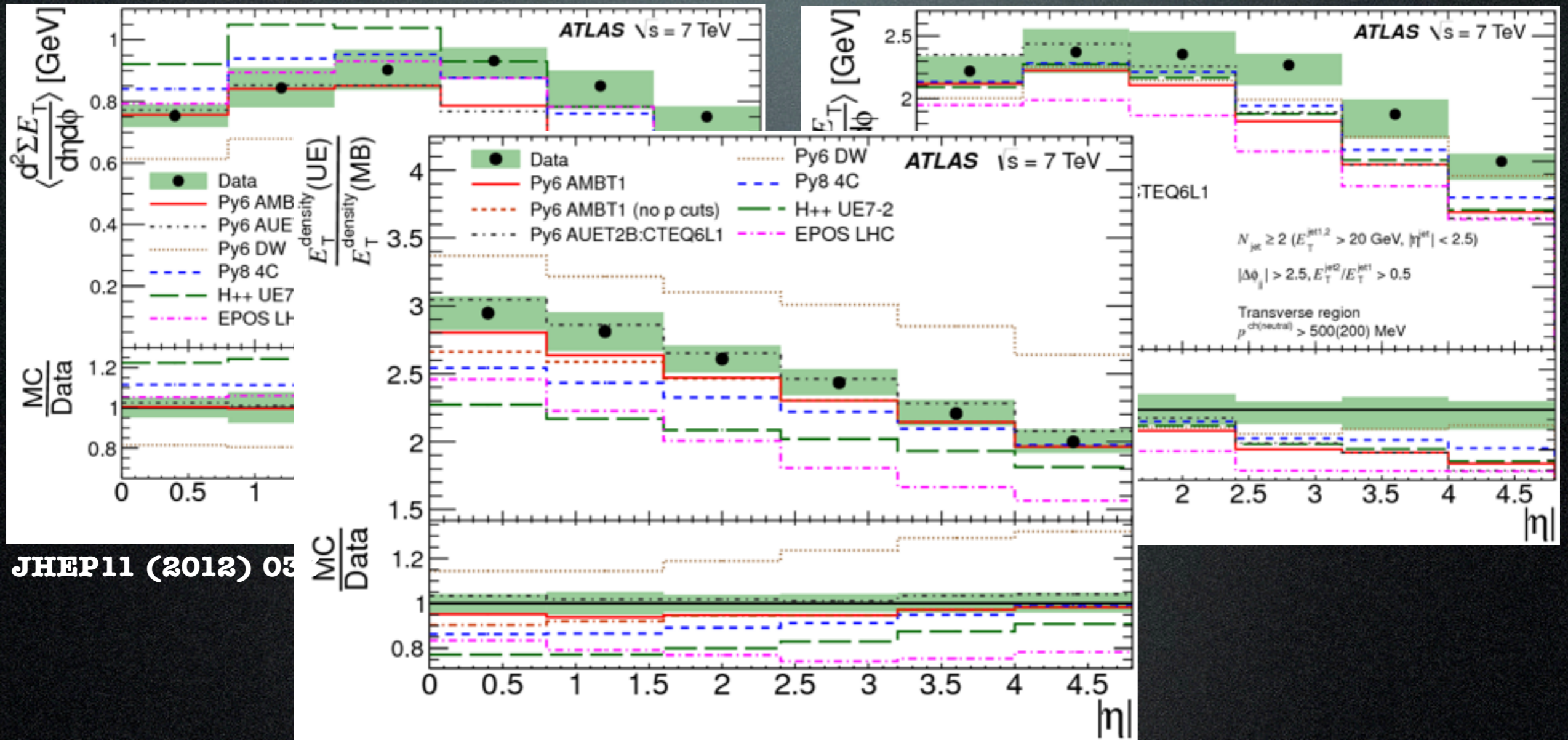

JHEP11 (2012) 05

More energy in dijet events!

# From Central to Forward

low  $\eta$

high  $\eta$

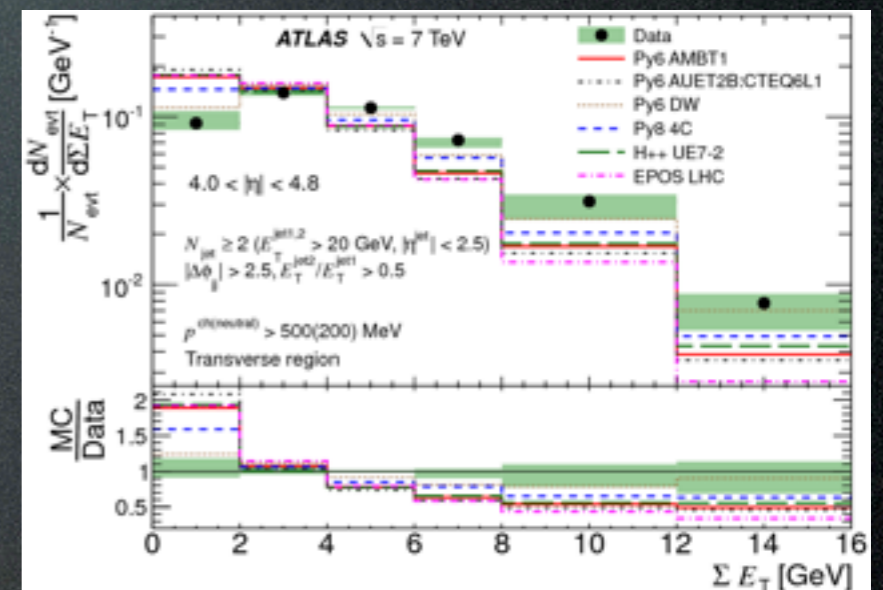
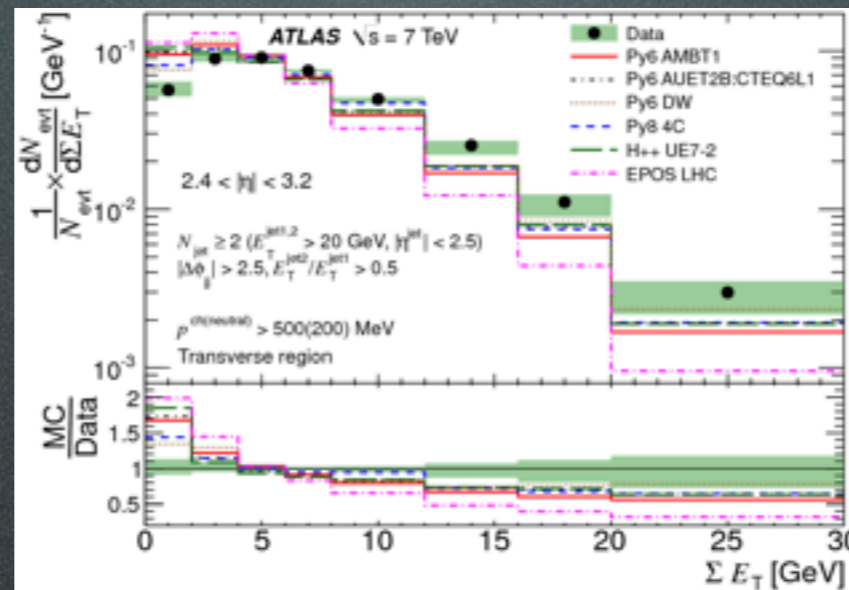
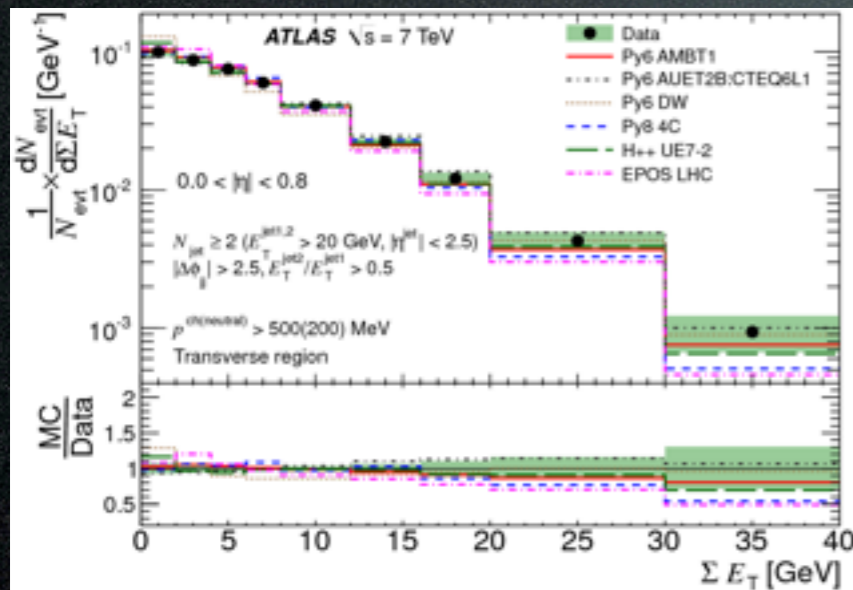

JHEP11 (2012) 033

UE tunes do better overall

# Event Shapes

Low lead  $p_T$

High lead  $p_T$

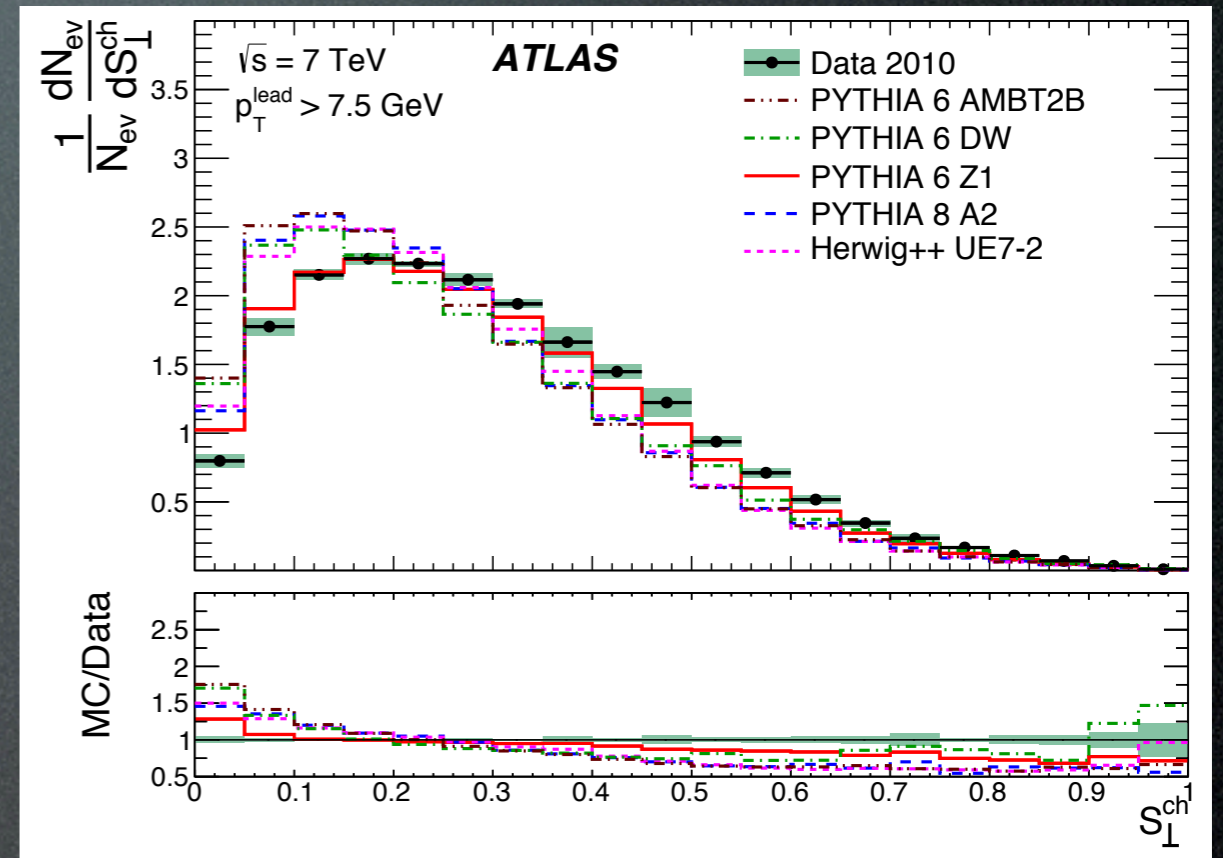
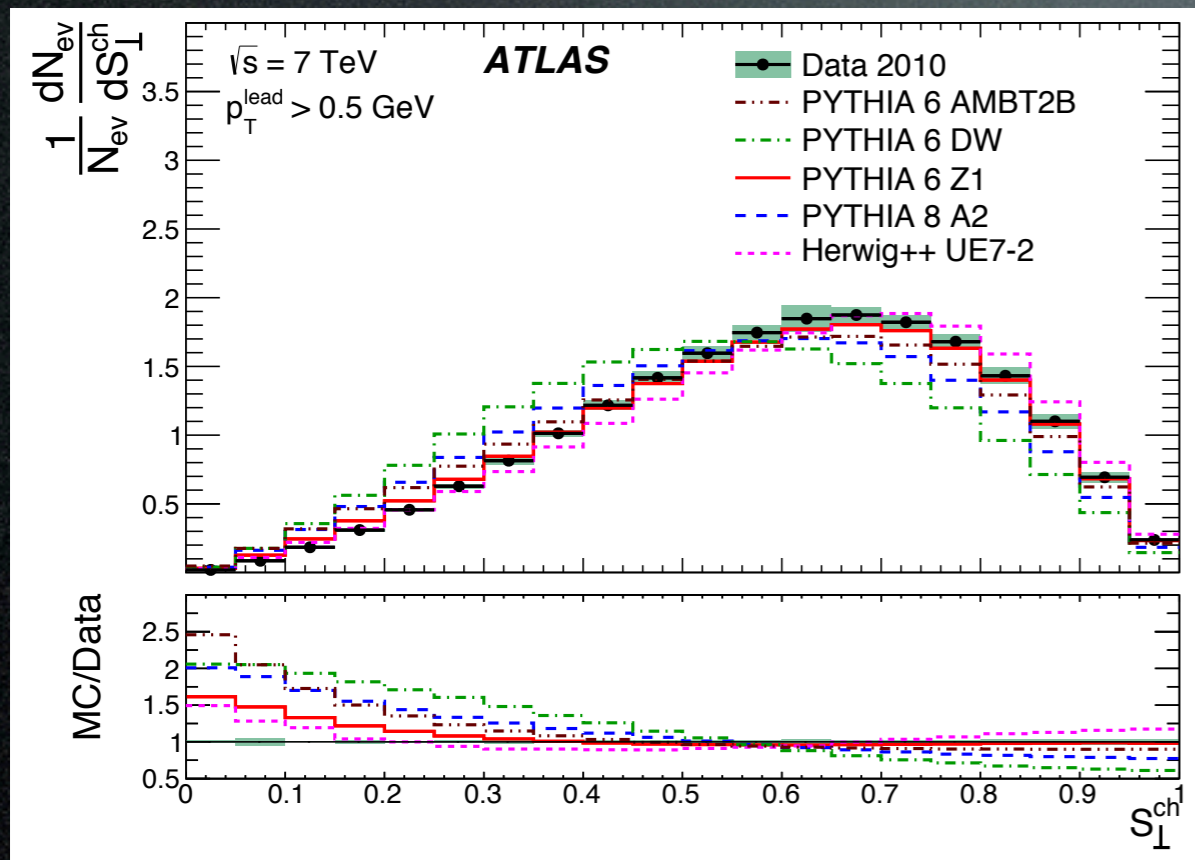

Phys. Rev. D 88, 032004 (2013)

UE starts taking over...

# Event Shape Profile

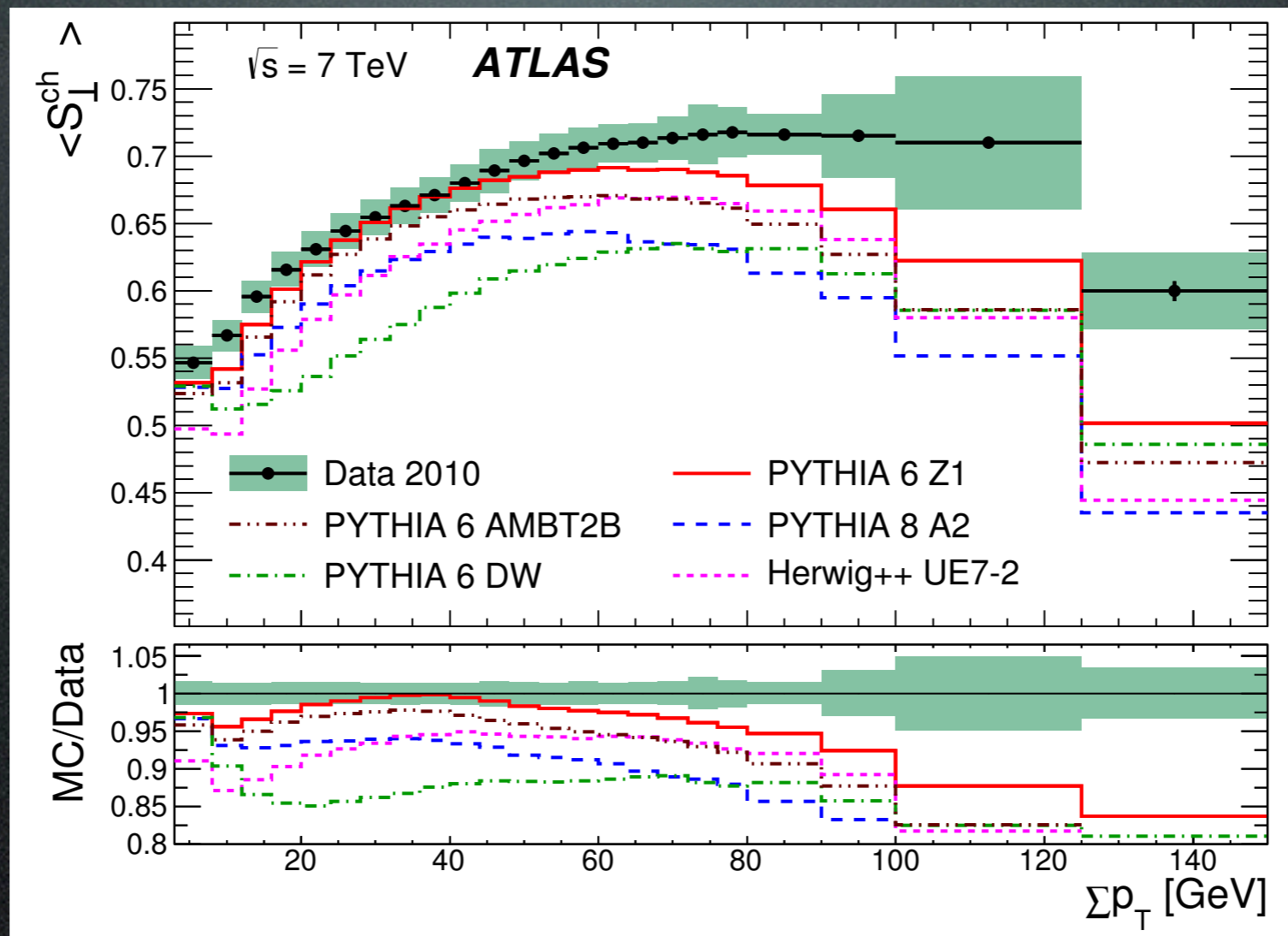

Phys. Rev. D 88, 032004 (2013)

Emergence of jets?



# Jet Substructure in Brief

# Large radius jets

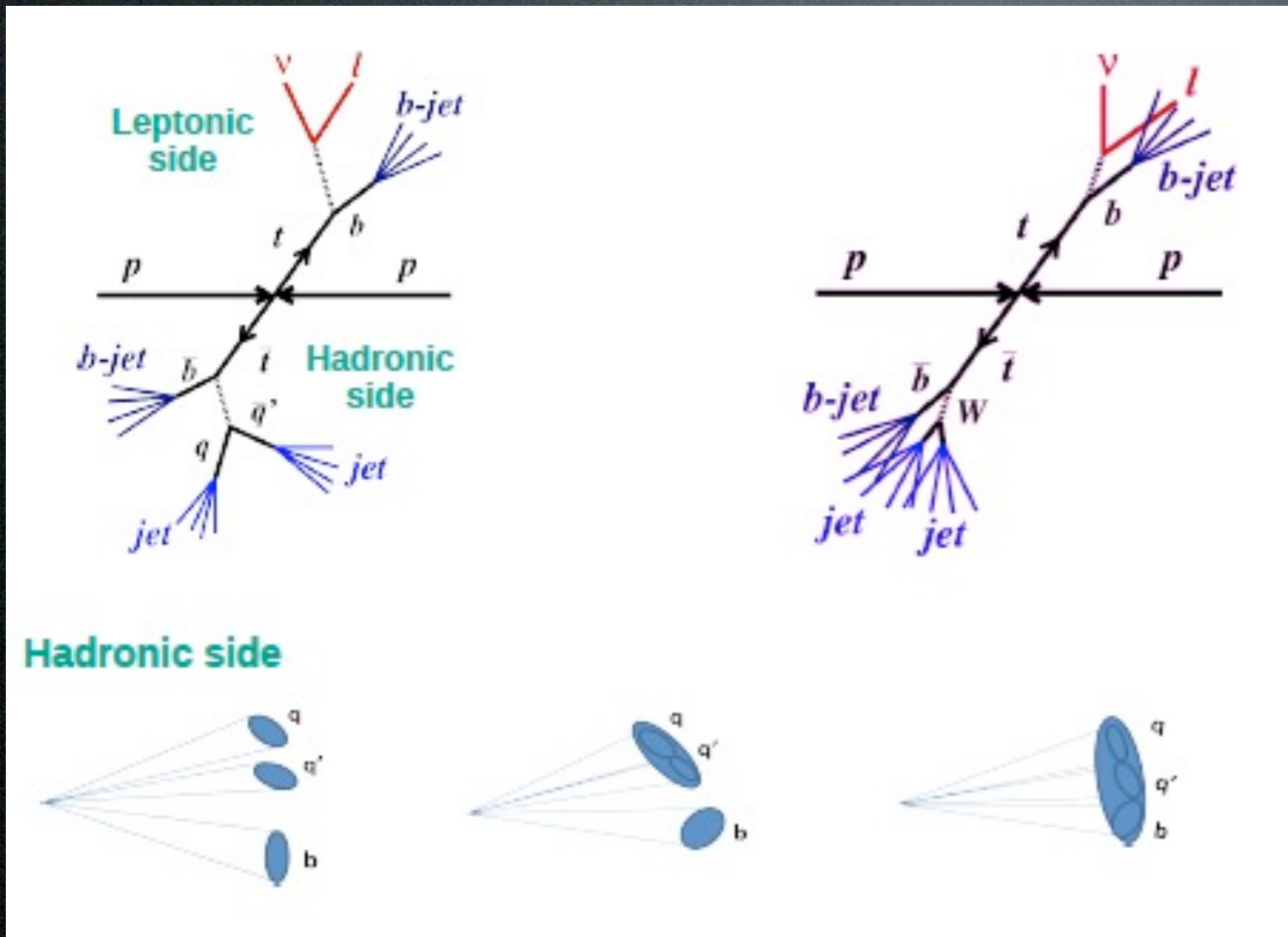

The angular resolution of the decay products:  
 $\Delta R \approx 2m/p_T$

So for a top quark (of mass 173 GeV) with  $p_T > 350$  GeV, we have  $\Delta R \sim 1$ .

With increasing c.m energy: collimated decay products from boosted heavy particles result in a single massive jet.

So when you take apart a jet, what does it look like?

So when you take apart a jet, what does it look like?



So when you take apart a jet, what does it look like?

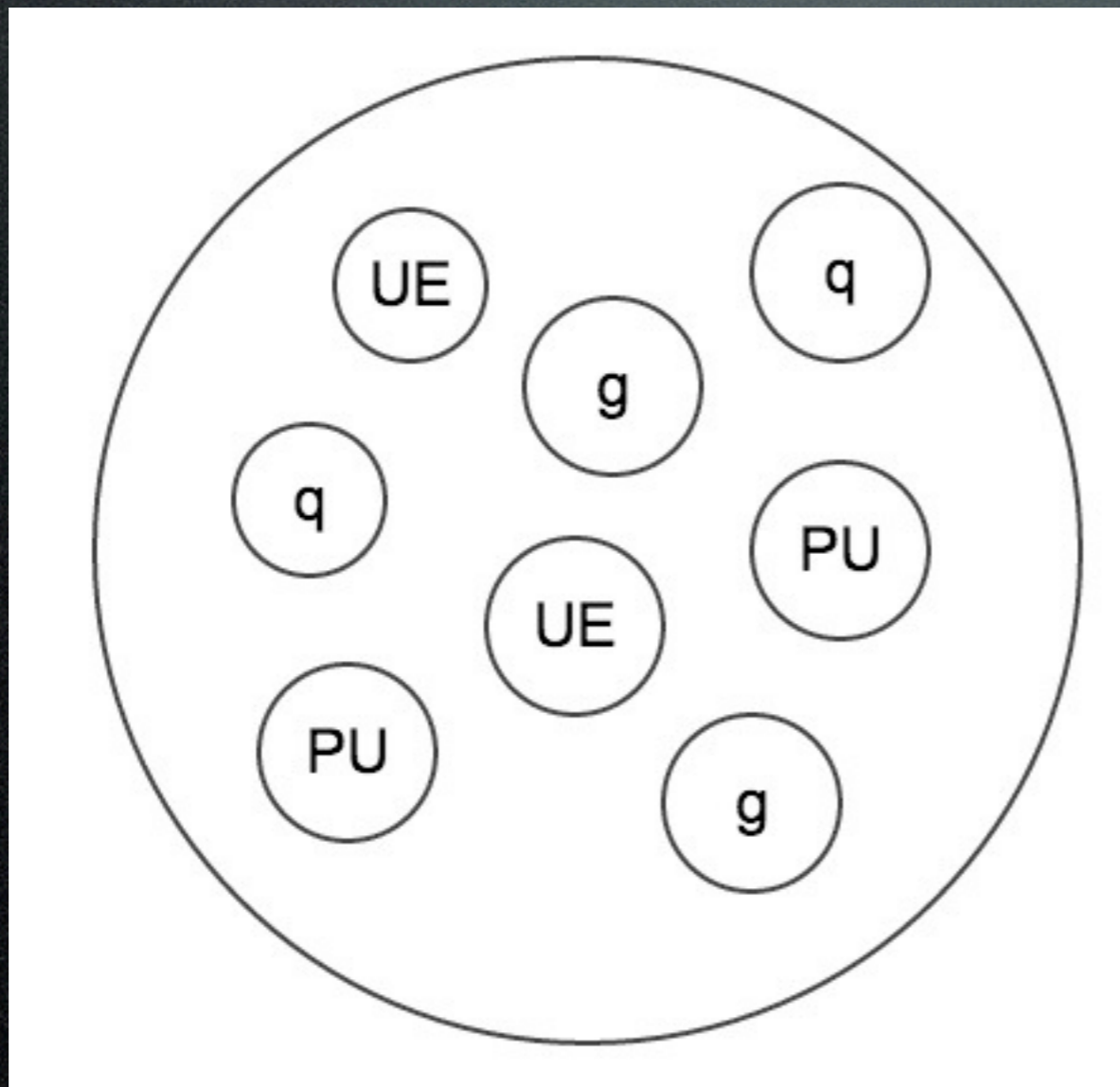

We want to exploit the “substructure” of the large-radius jet to identify original particles

# Substructure Techniques

- Jets need to be “groomed”.

The large-radius jets not only include particles coming from the interesting decays, but also from pileup, underlying event ....

- Need observables which would be sensitive to signal-like or background-like nature of these jets.

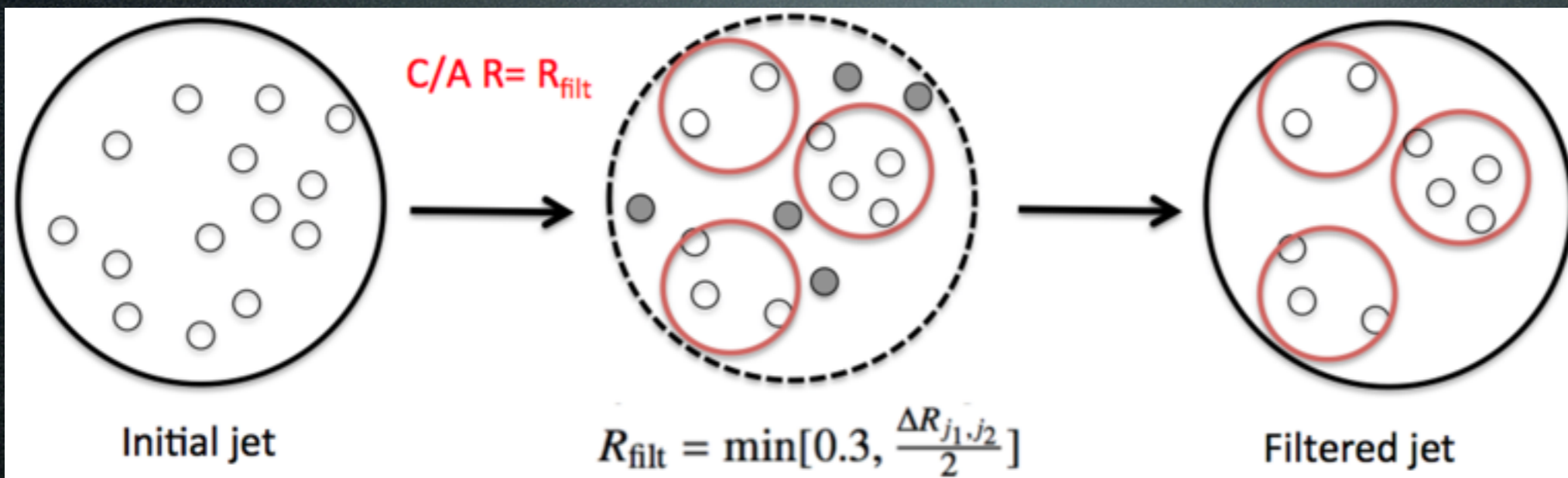

Filtering

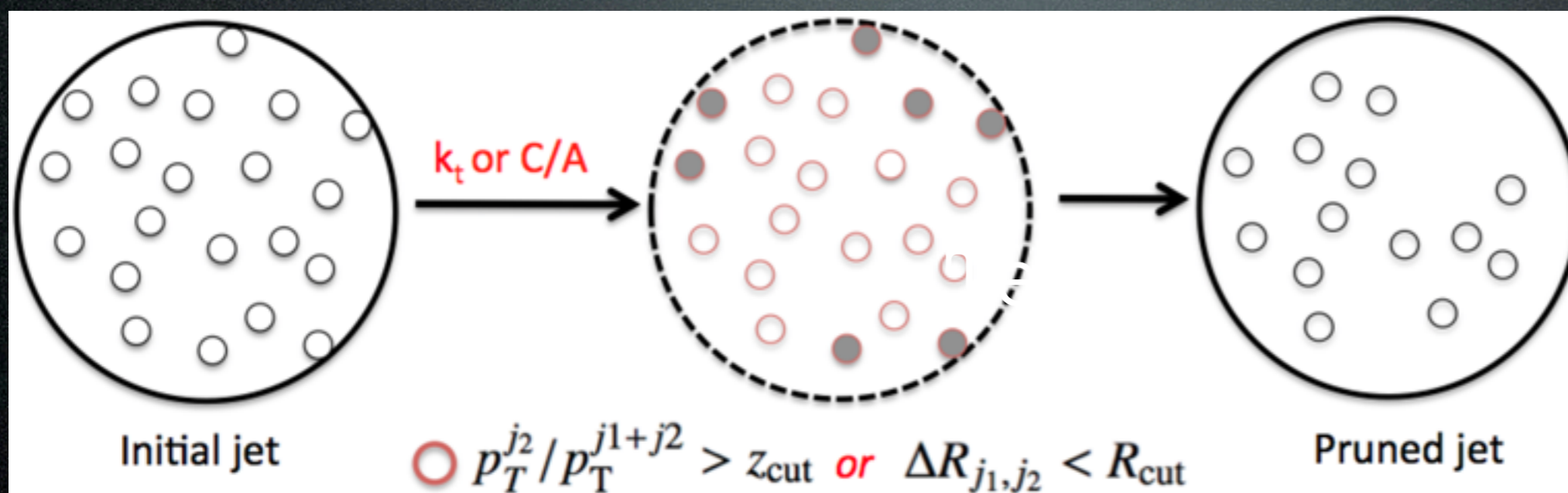

Pruning

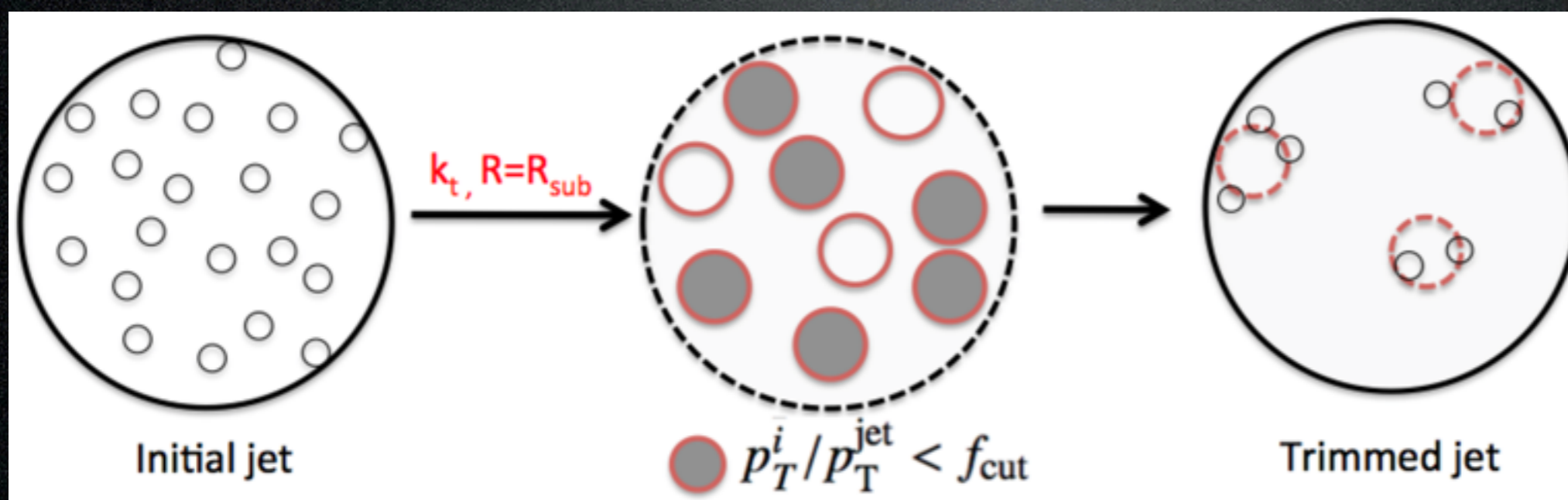

Trimming

# Tagging Top or Higgs

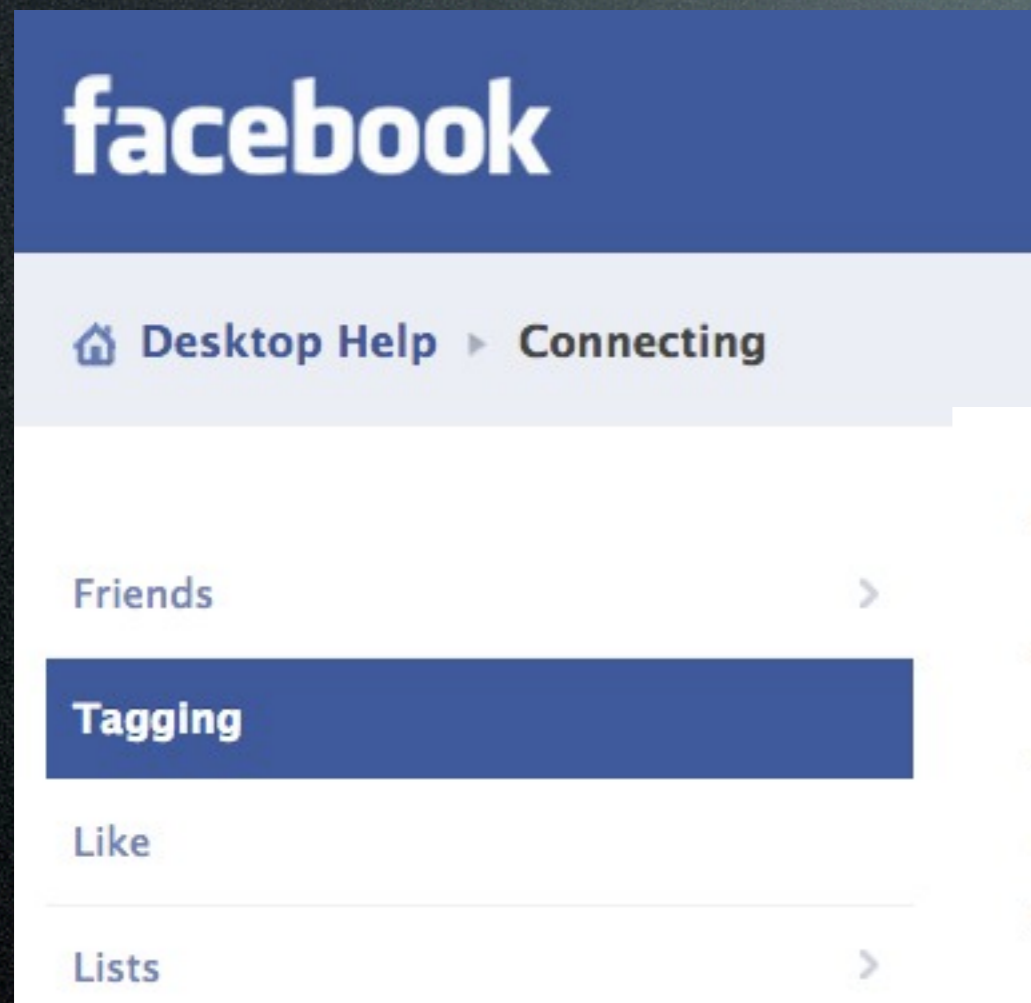

particles

## ~~Tag people in your posts~~

Add tags to anything you post, including photos and updates. Tags can point to your friends or anyone else on Facebook. Adding a tag creates a link that people can follow to learn more.

- Target is to identify jets resulting from the decay of top quark or Higgs against jets coming from light quark/gluons.



Playing with the Shower

# Recall

Top quark decay:

Parton Shower!

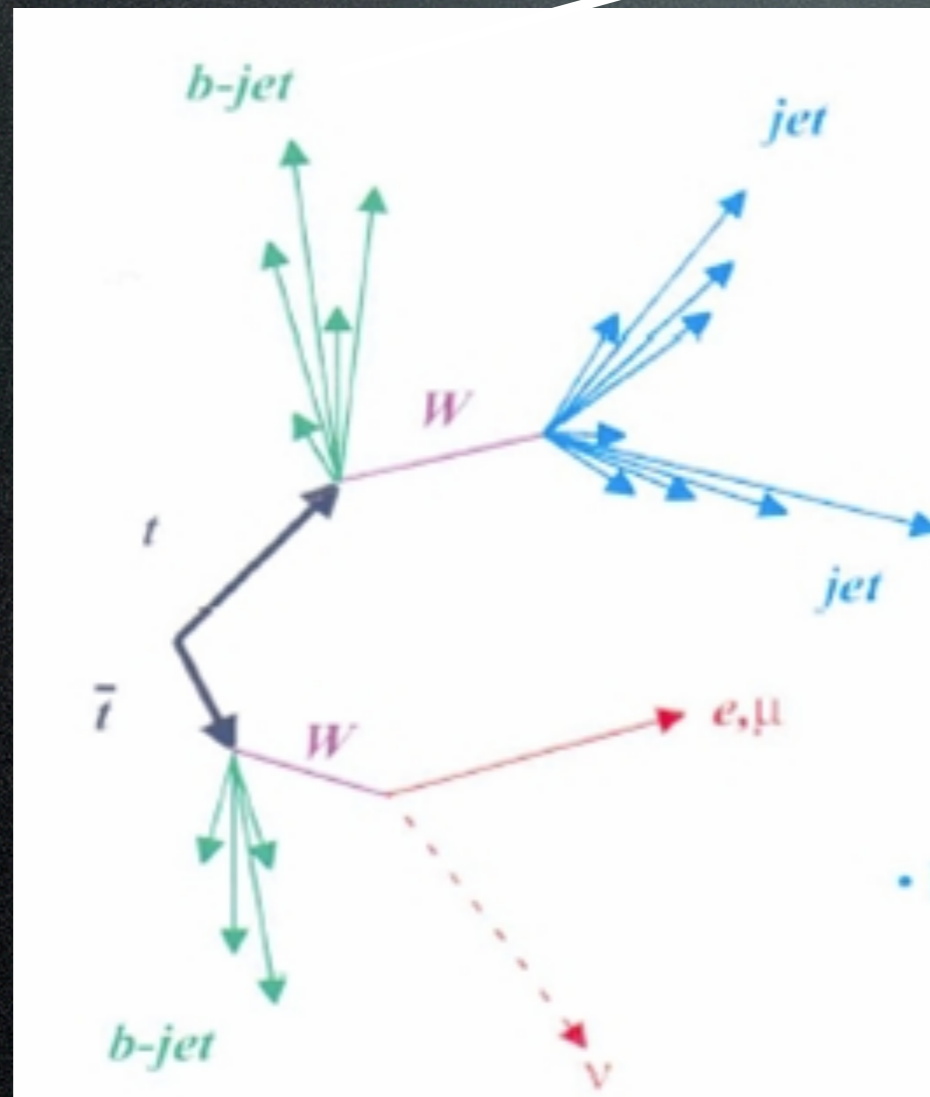

# Reversing the Shower



# Shower Deconstruction

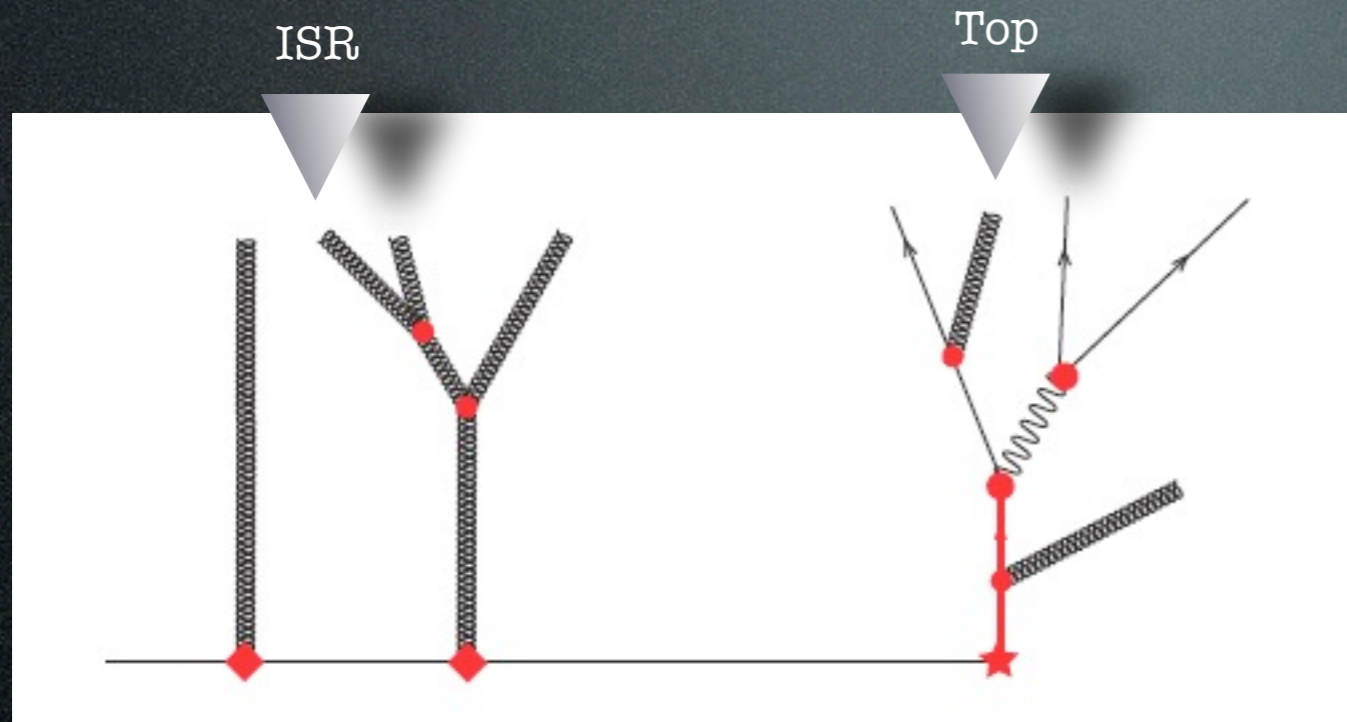

Top quark jet  
shower history

vs.

Light quark jet  
shower history

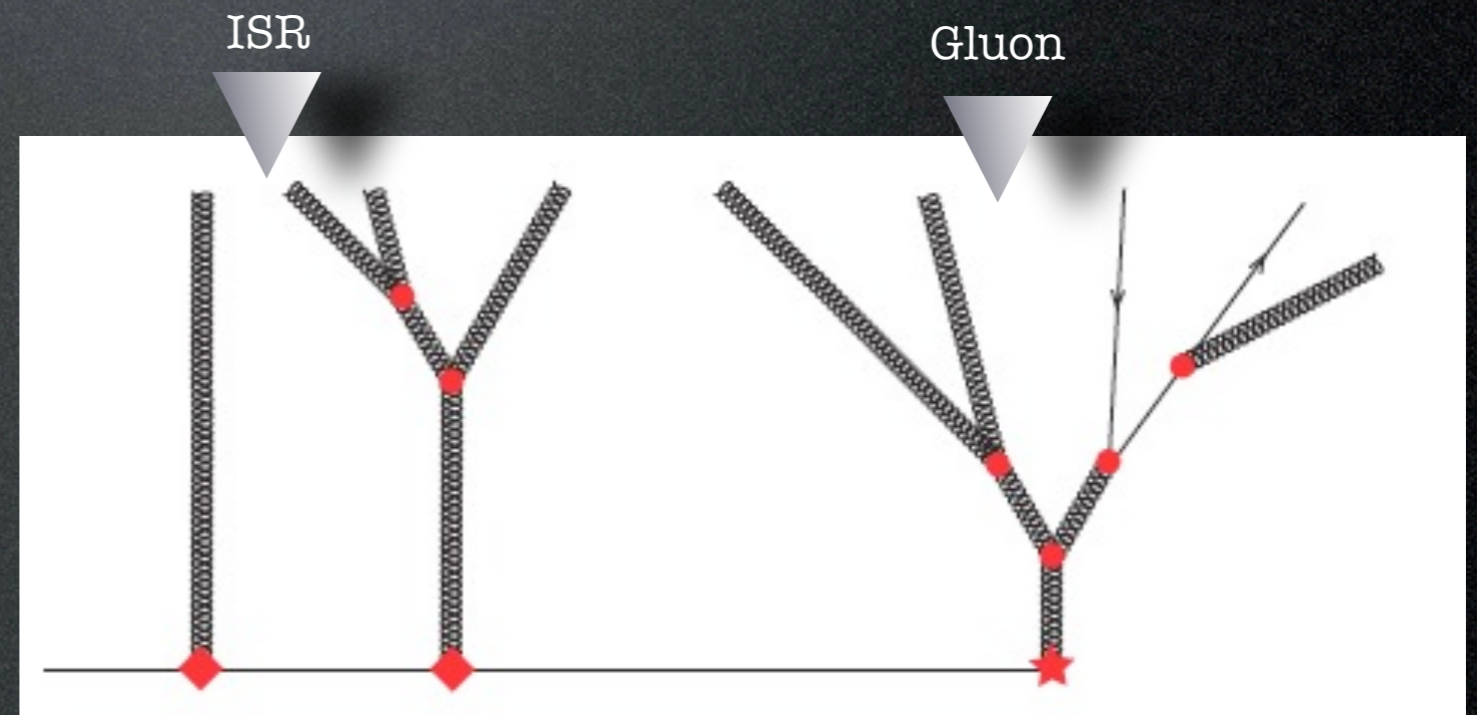

# Shower Deconstruction

- Decompose the large-radius jet into small radius **sub/microjets**.
- Build all possible shower histories with the microjets.
- Assign probability whether signal-like or background-like.
- A single analytic function:

$$\chi(\{p\}_N) = \frac{P(\{p\}_N|S)}{P(\{p\}_N|B)}$$

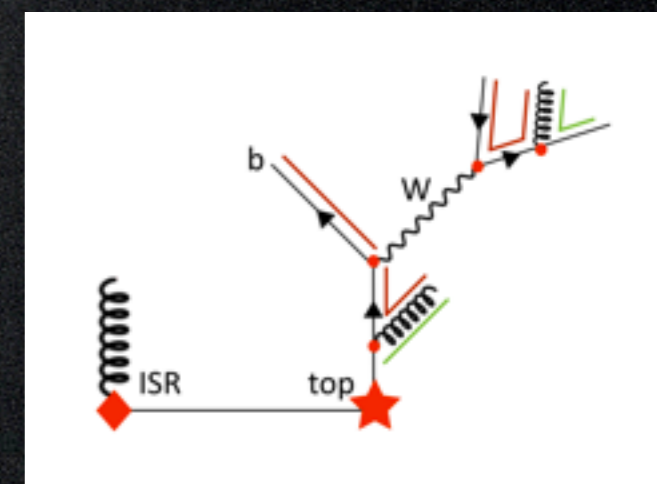
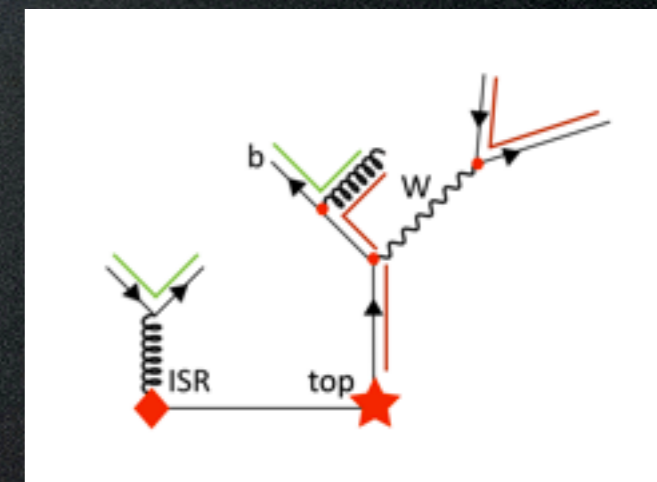
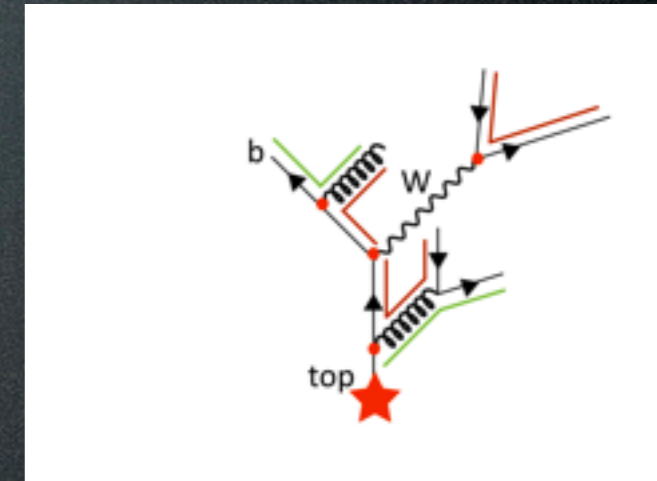
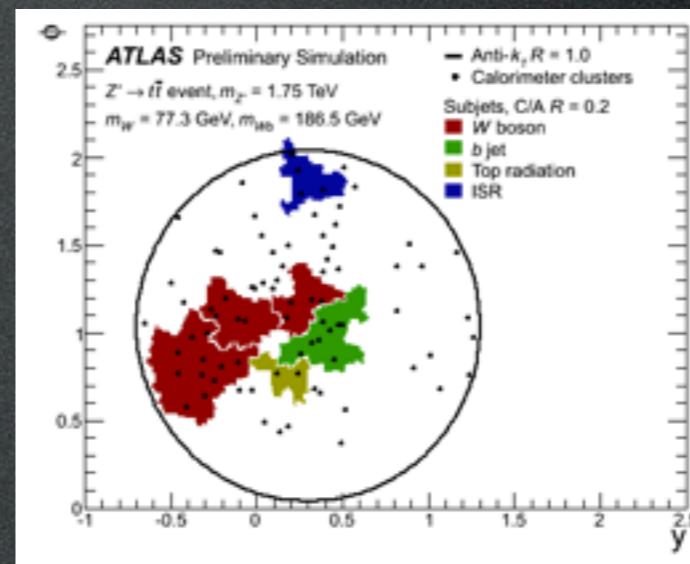
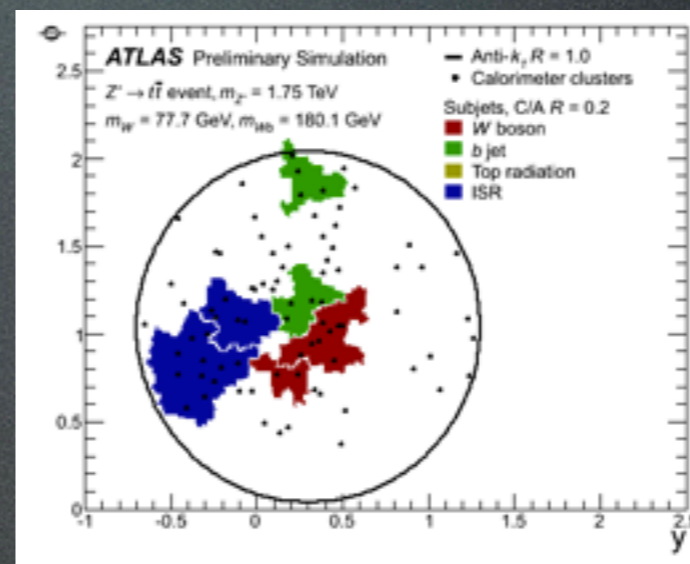
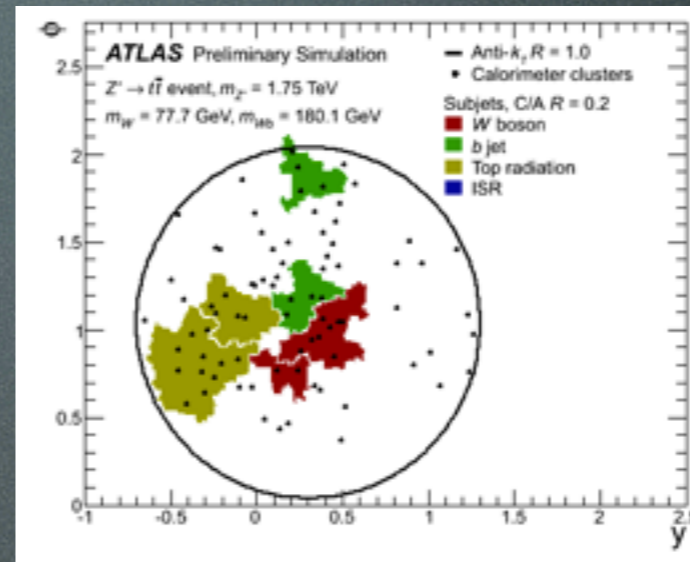

# Looking at our Data

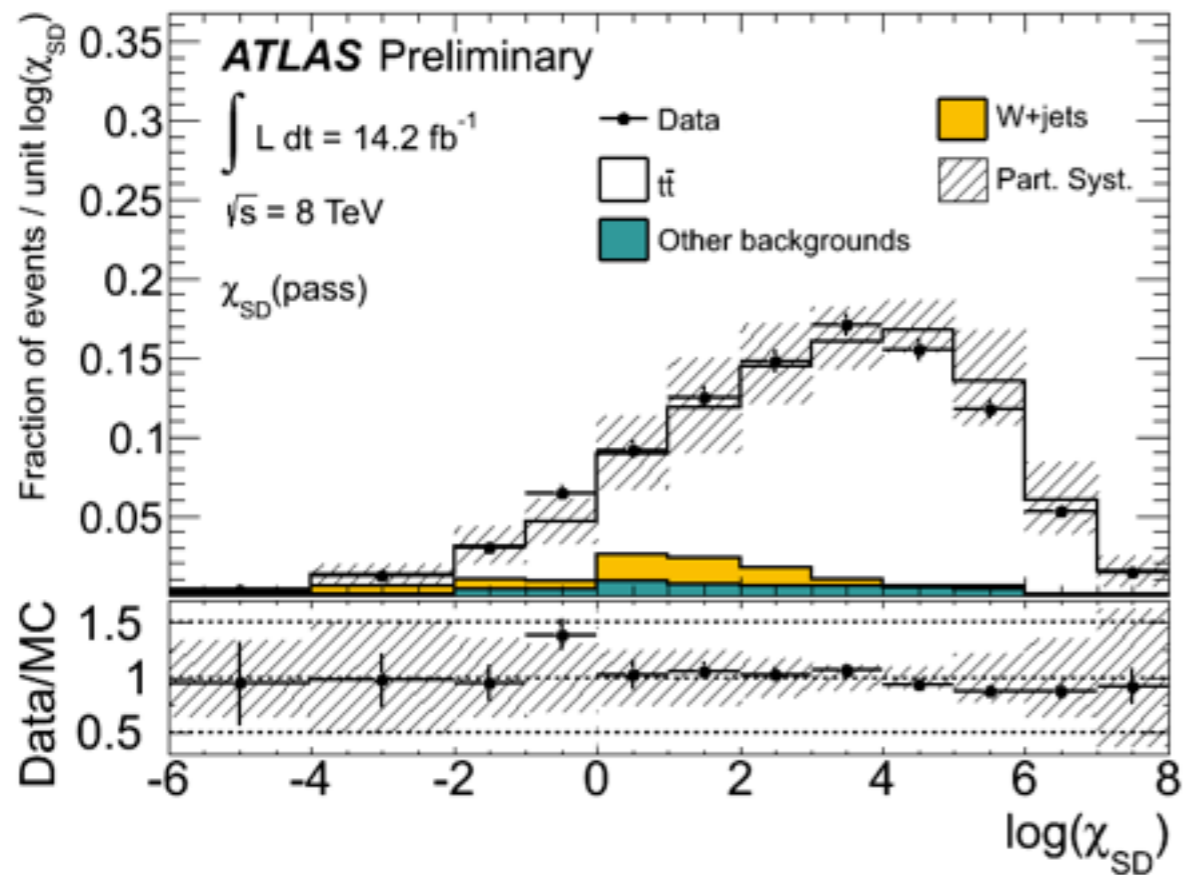

LogChi modelled well by MC

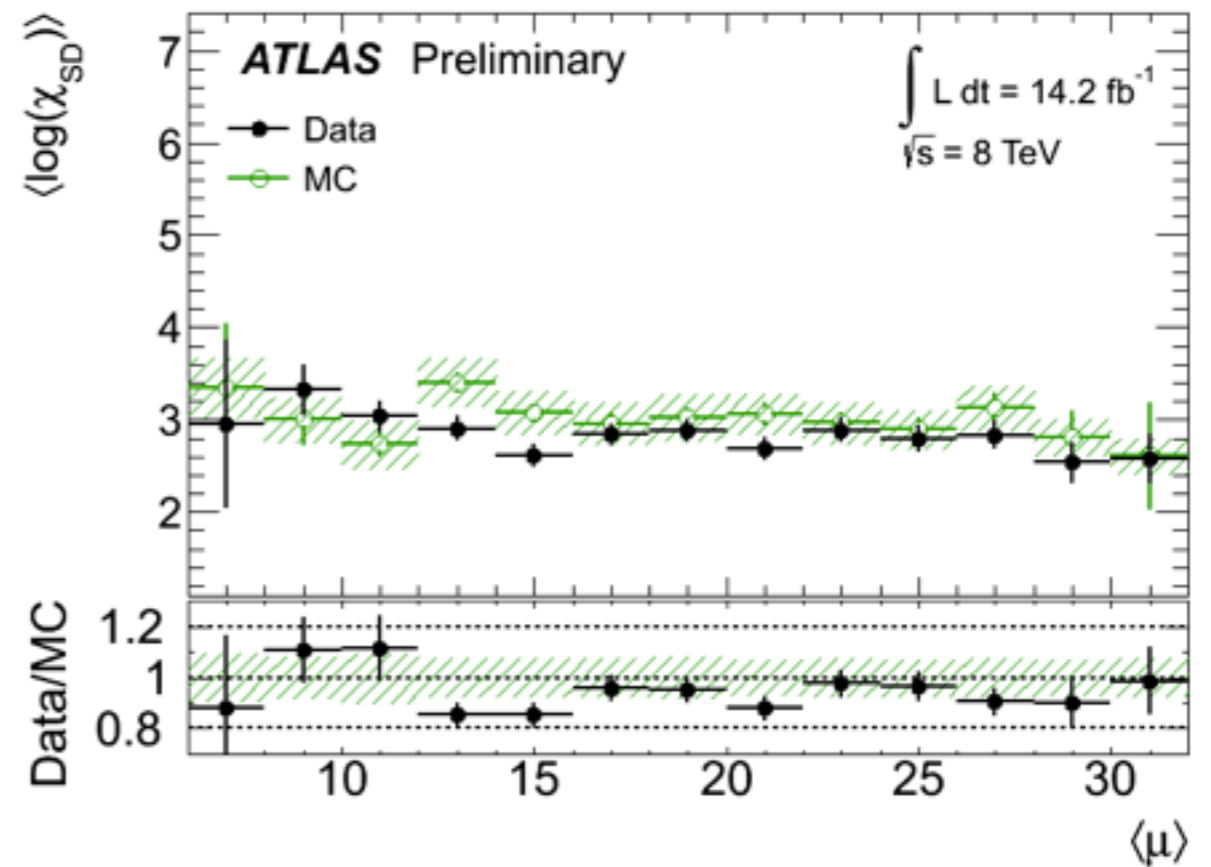

LogChi robust against pileup

# Signal and BG Discrimination

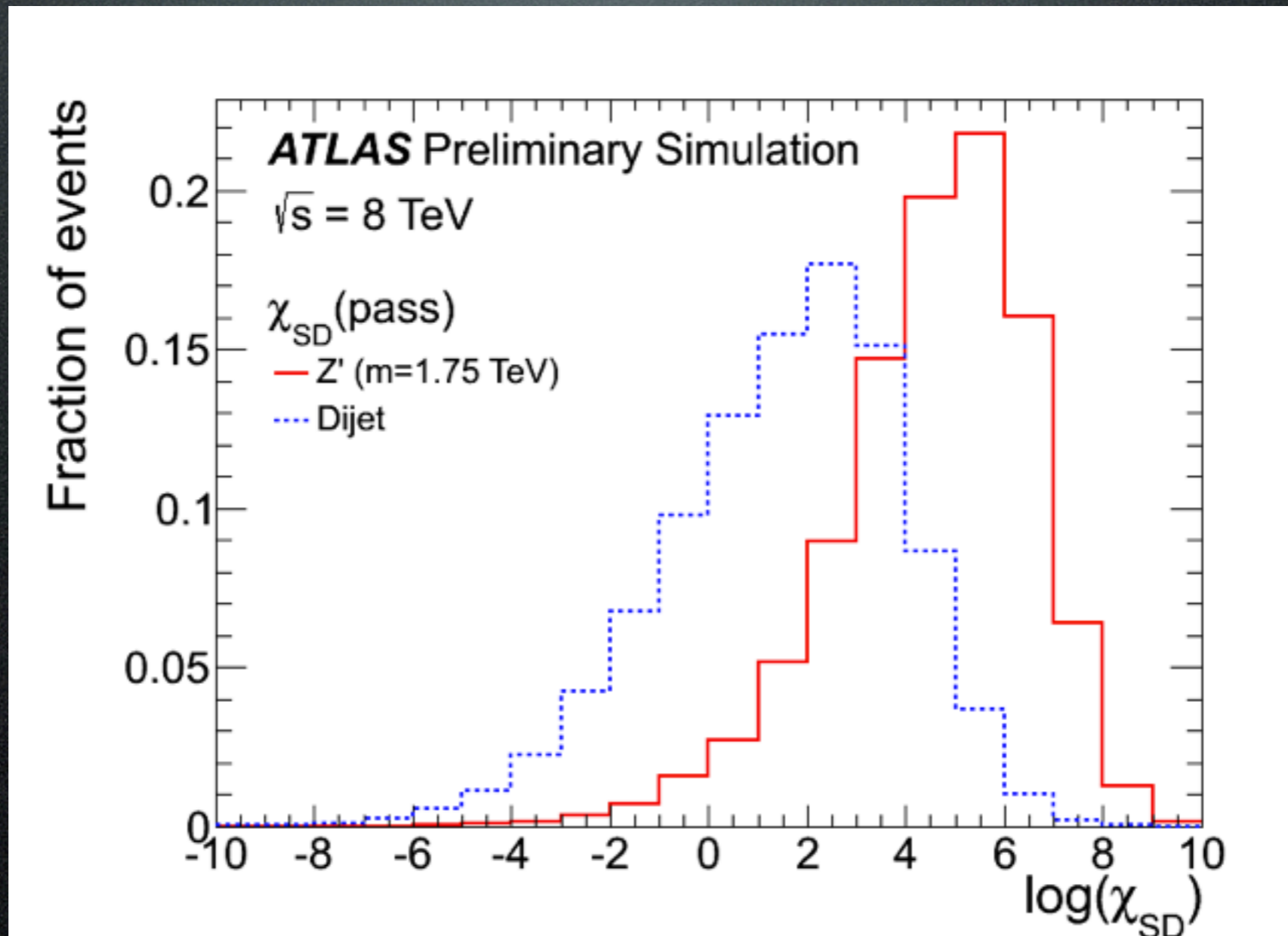

# Top-Tagging Comparison

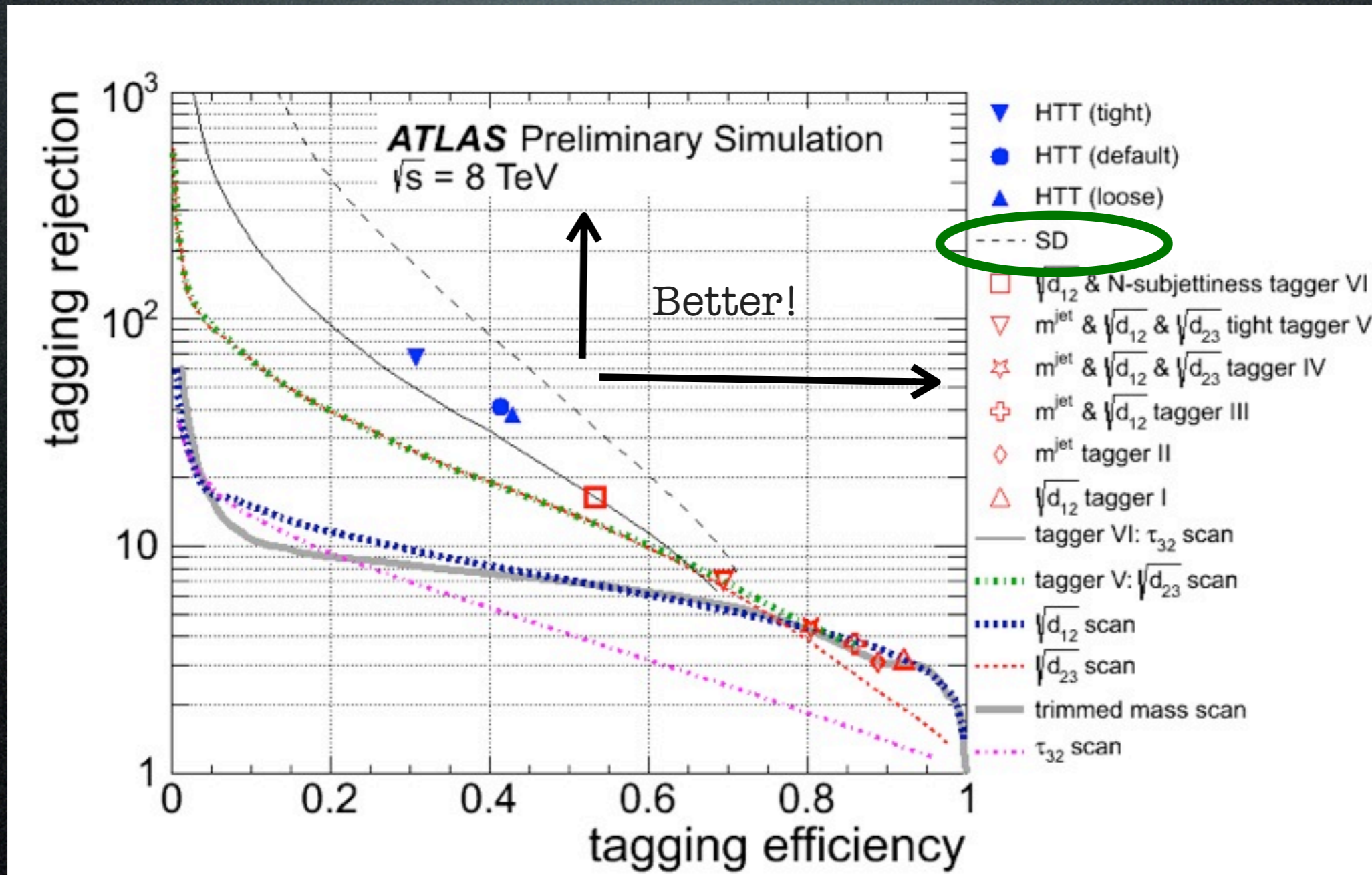

Better top quark finding efficiency at the same rejection of multijets when compared to the HEPTopTagger.



# Summary

- Soft QCD is fun (and useful).
- Tuning is fun too, but hard to get everything right.
- Generators contain a lot under their hood, and it is good to have some understanding of it.
- The improved modelling of low  $p_T$  processes is feeded back to full event generation, where it affects high  $p_T$  part of the event, especially for precision measurements.
- Jet substructure techniques utilise the knowledge and modelling of shower, so direct application in searches as well.

# Supporting Material



# Powheg+Pythia8

## Matching

(ongoing Les Houches Study)

- PoWHEG provides a scale (SCALUP) that is an indication of where the shower should take over from the perturbative calculation.
- What should be this scale?
- Imperfection in transition region

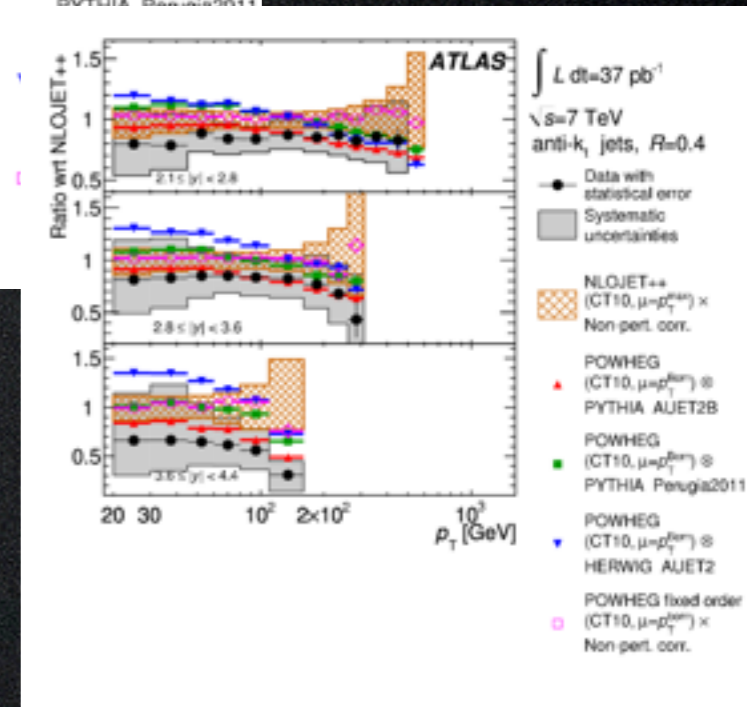
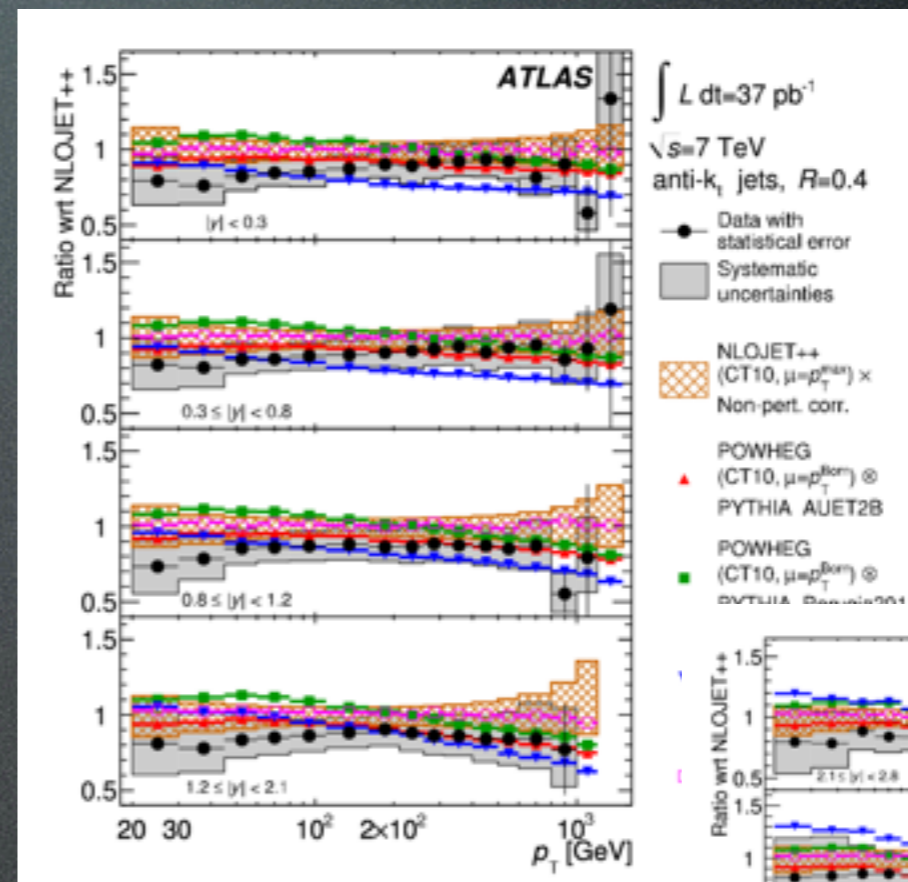

# 14 TeV UE Predictions

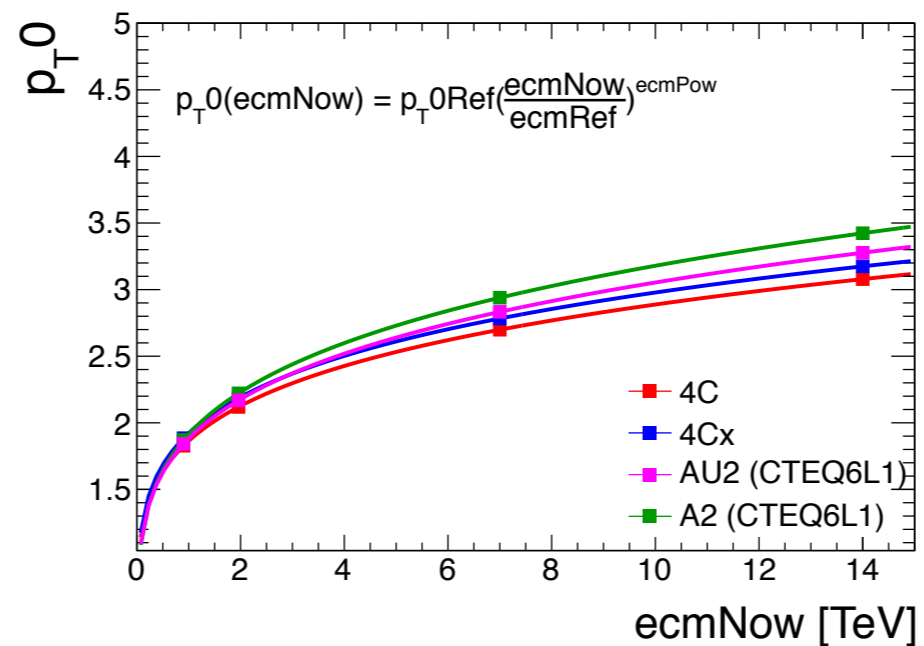
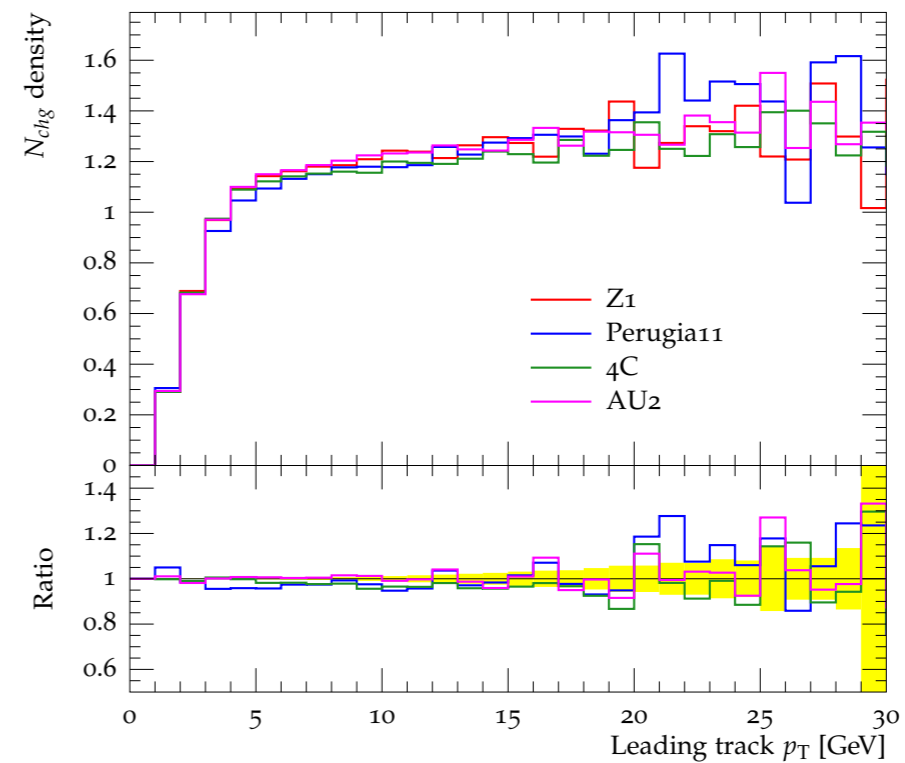
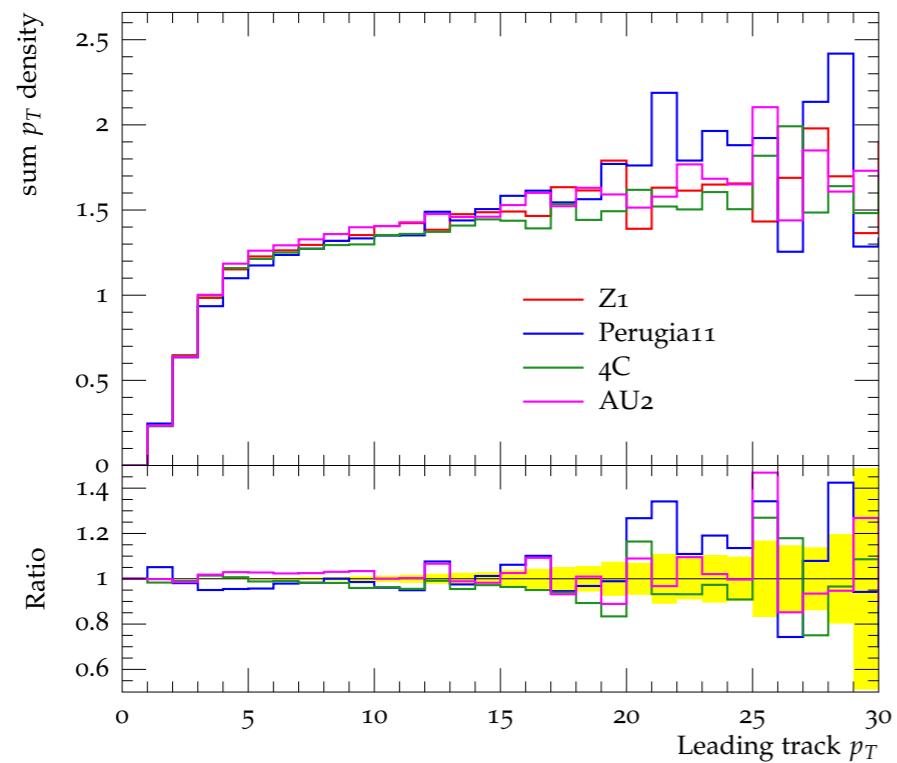

# Effect of Grooming on Pileup

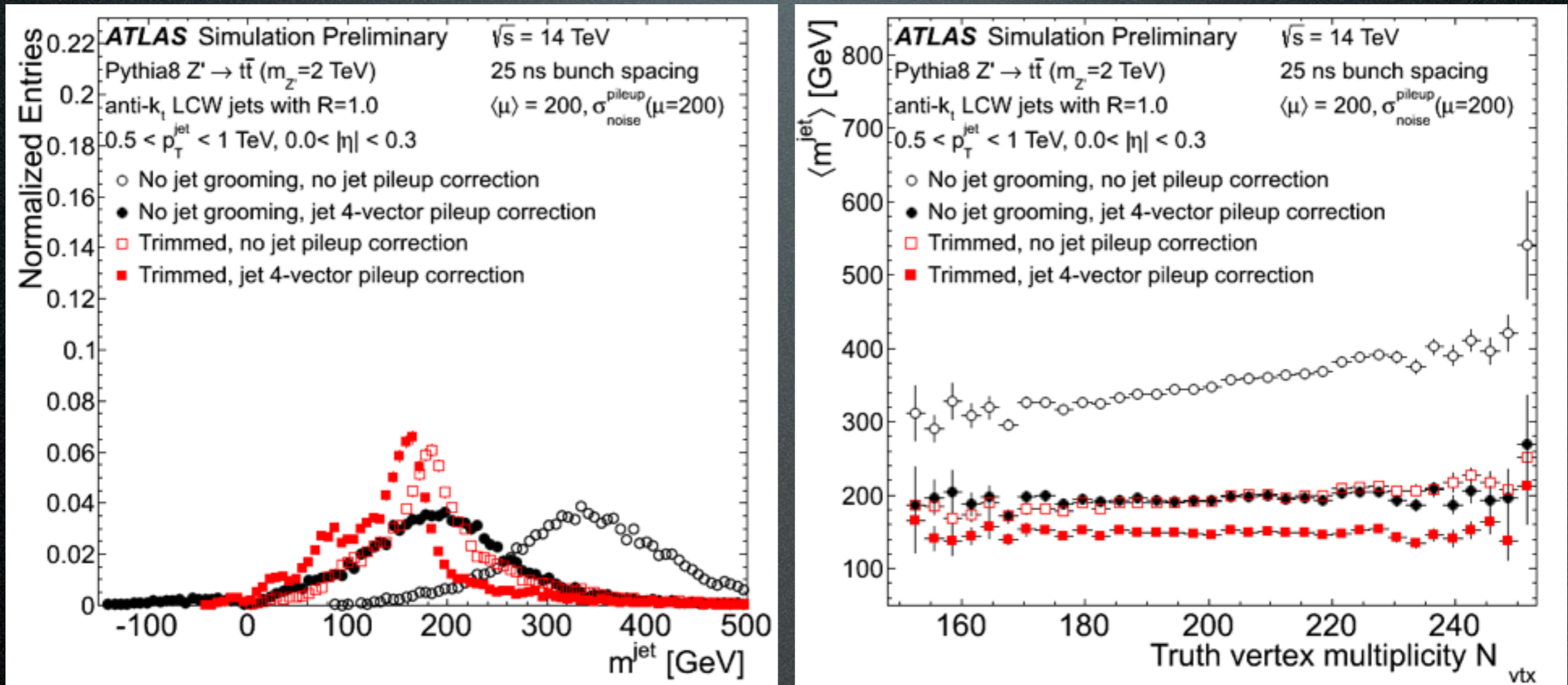

# Jet Mass

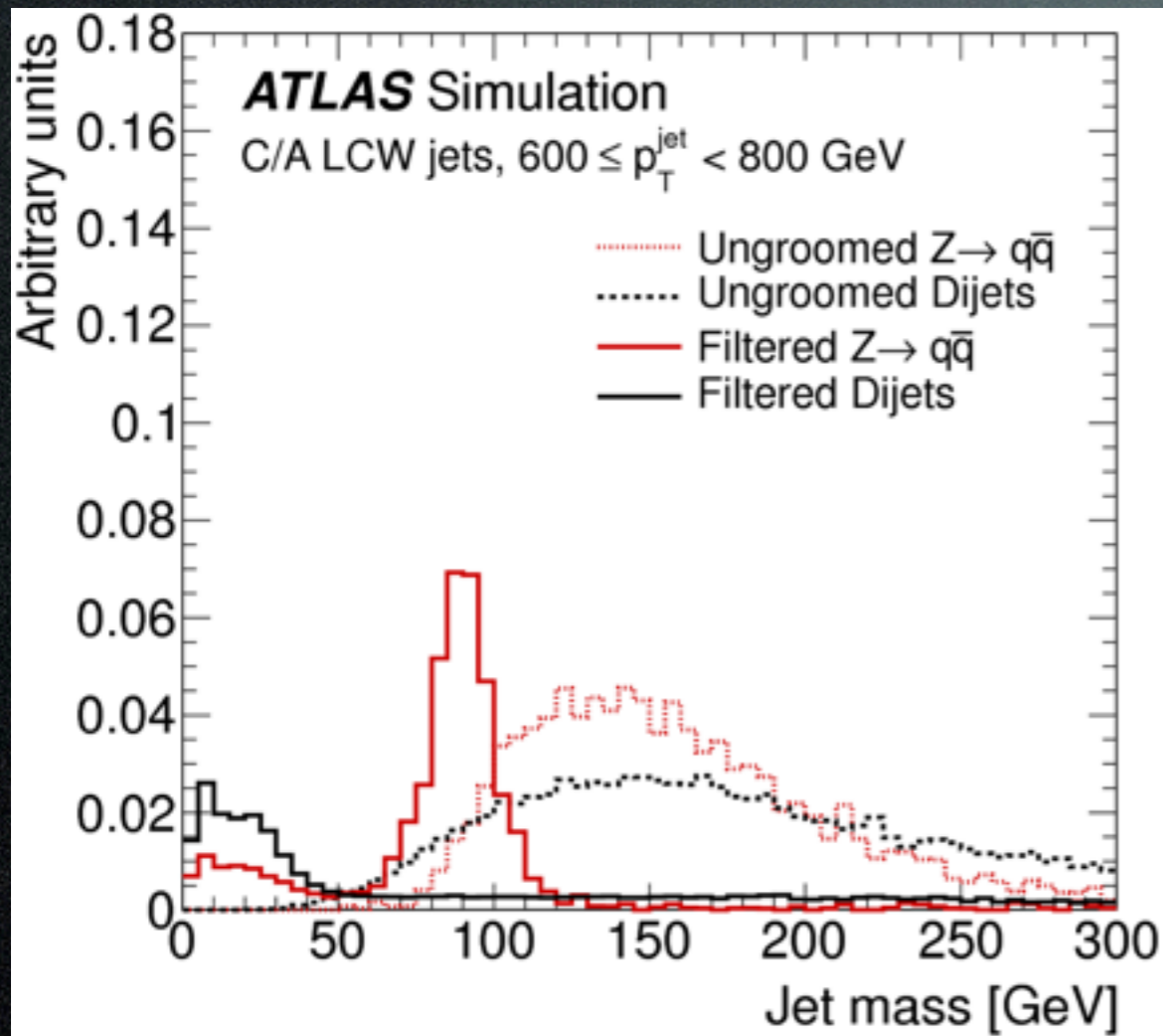

arXiv:1306.4945v1

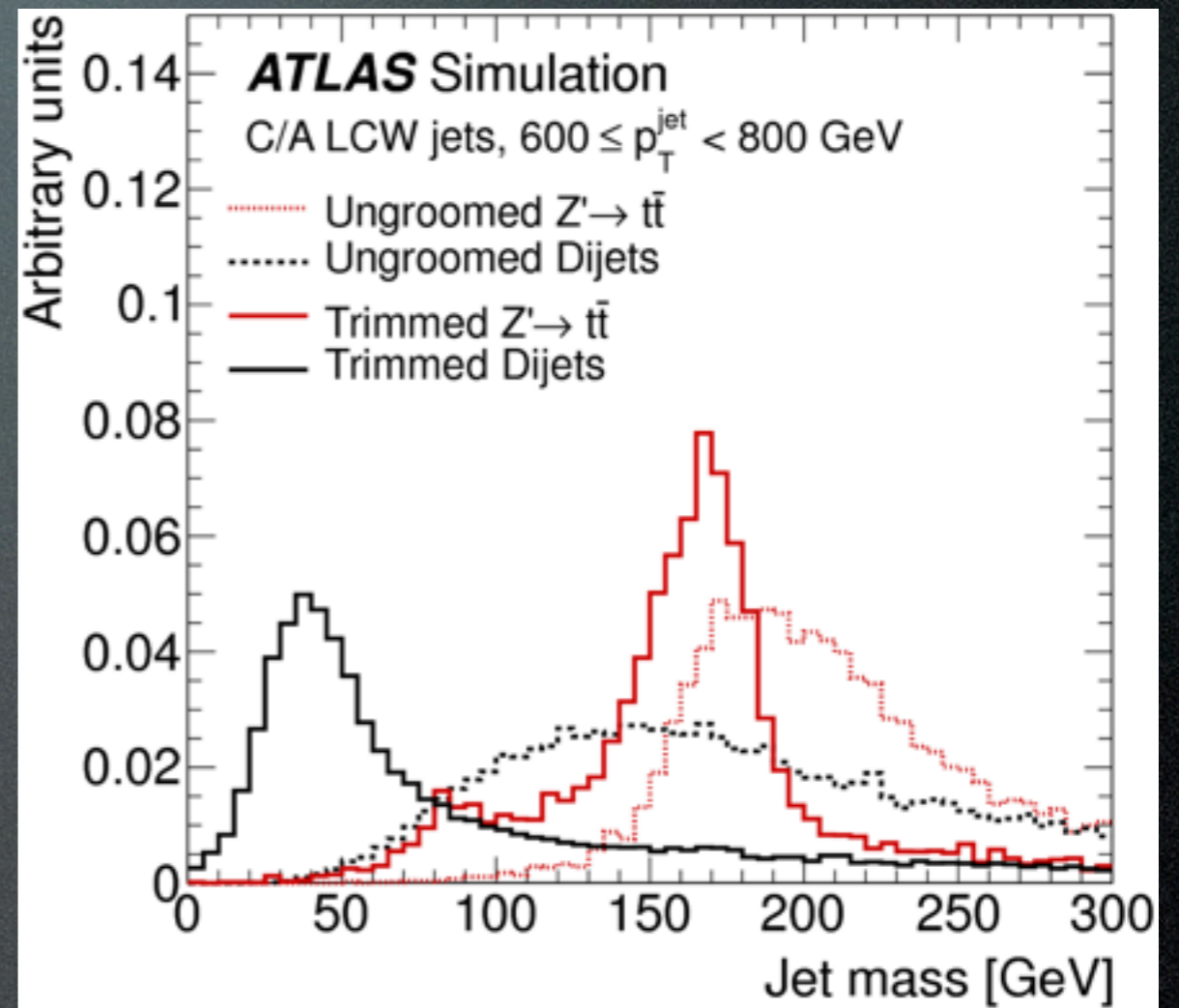

arXiv:1306.4945v1

Clear peak visible after grooming

# $k_t$ Splitting Scale

$$\sqrt{d_{ij}} = \min(p_{Ti}, p_{Tj}) \times \Delta R_{ij}$$

When combining two subjets with  $k_t$  algorithm:

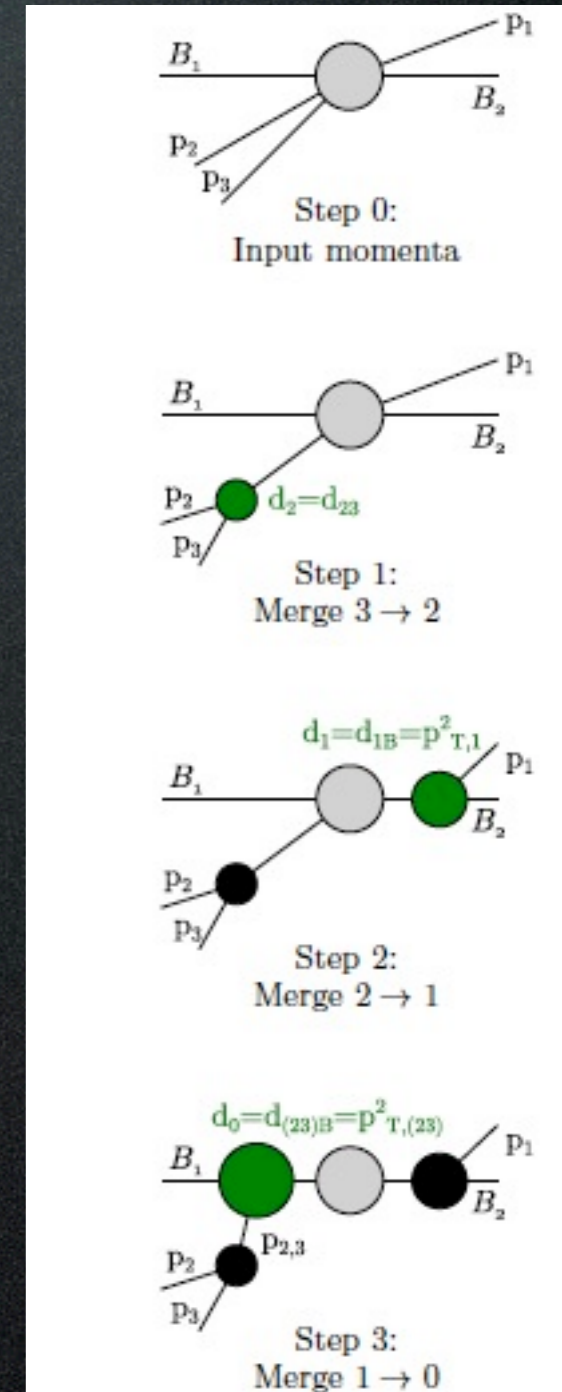
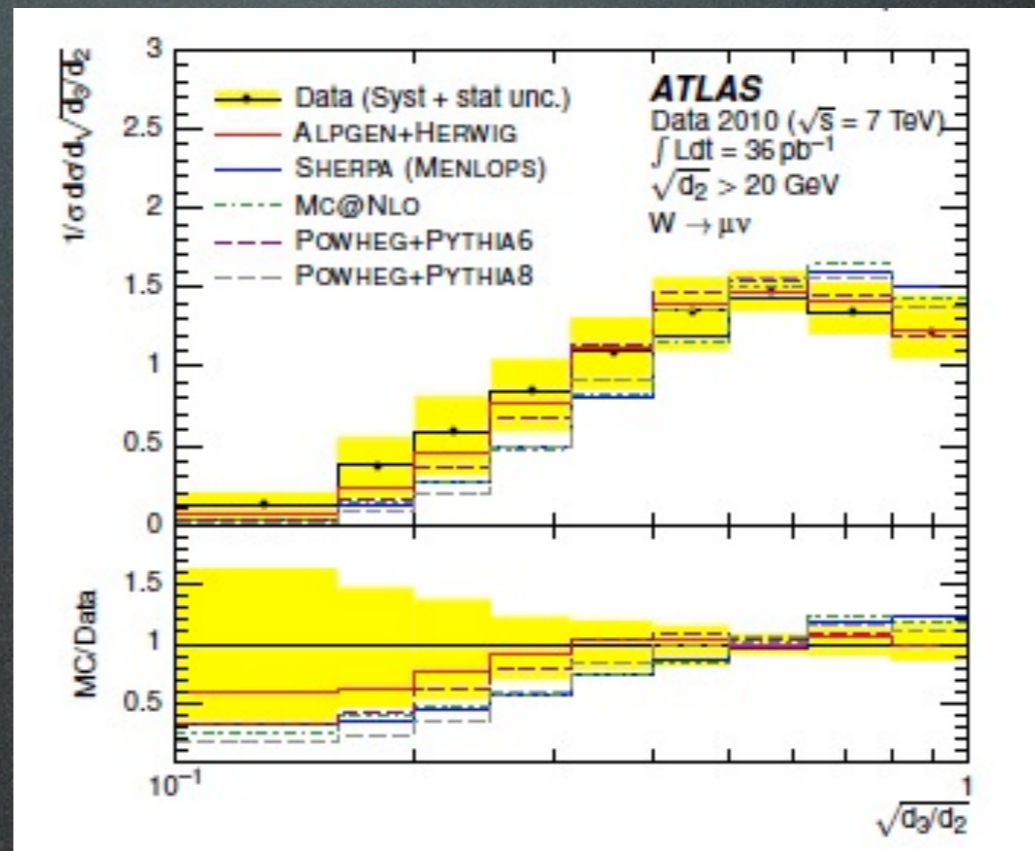
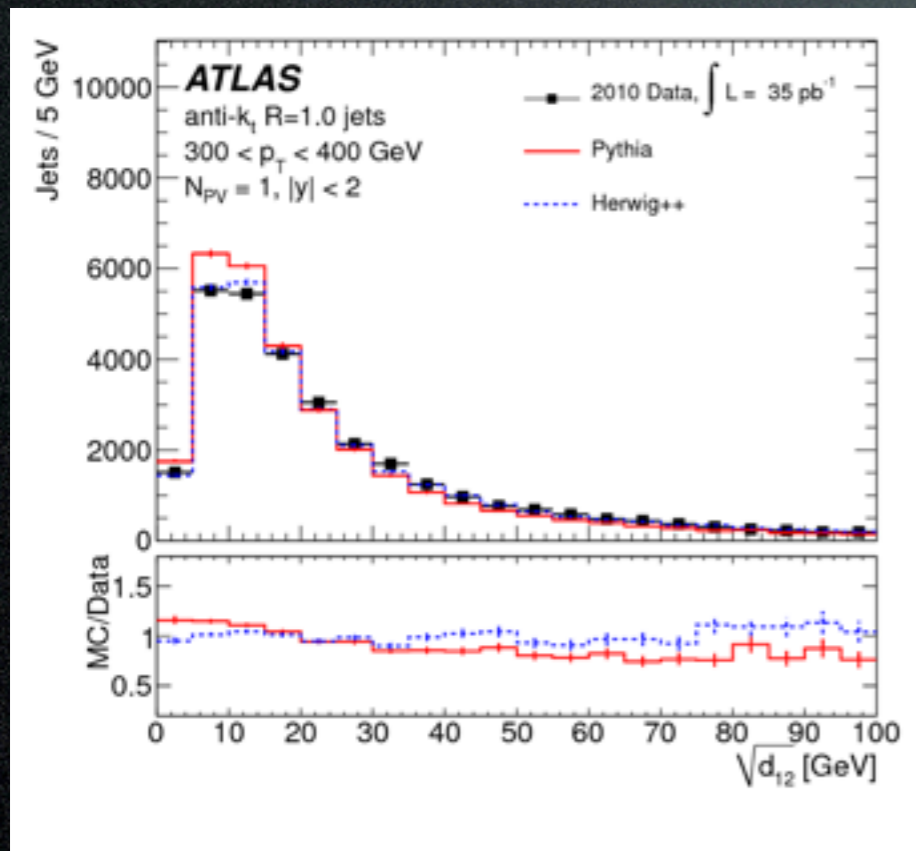

[arXiv:1203.4606](https://arxiv.org/abs/1203.4606)

[arXiv:1302.1415](https://arxiv.org/abs/1302.1415)

[arXiv:1302.1415](https://arxiv.org/abs/1302.1415)

Symmetric for heavy particle two body decay

# N-Subjettiness

Quantify the degree to which jet radiation is aligned along specific subjet axes.

$$\tau_N \equiv \frac{1}{d_0} \sum_{k=1}^M \left( p_{T,k} \times \underbrace{\Delta R_{\min,k}}_{\text{distance to nearest subjet}} \right)$$

$$d_0 = R \times \text{sum of } p_T \text{ of all constituents}$$

Smaller values: N or less energy deposits

Larger values: more than N energy deposits

No of Subjets:  $\leq N$   $> N$

---

$\tau_N = 0$   $\tau_N = 1$

Calculated by  $k_t$  clustering the constituents, and requiring exactly N subjets



# N-Subjettiness

The ratio  $\tau_N/\tau_{N-1}$  is used as discriminant



More like 2 subjects than 1



More like 3 subjects than 2

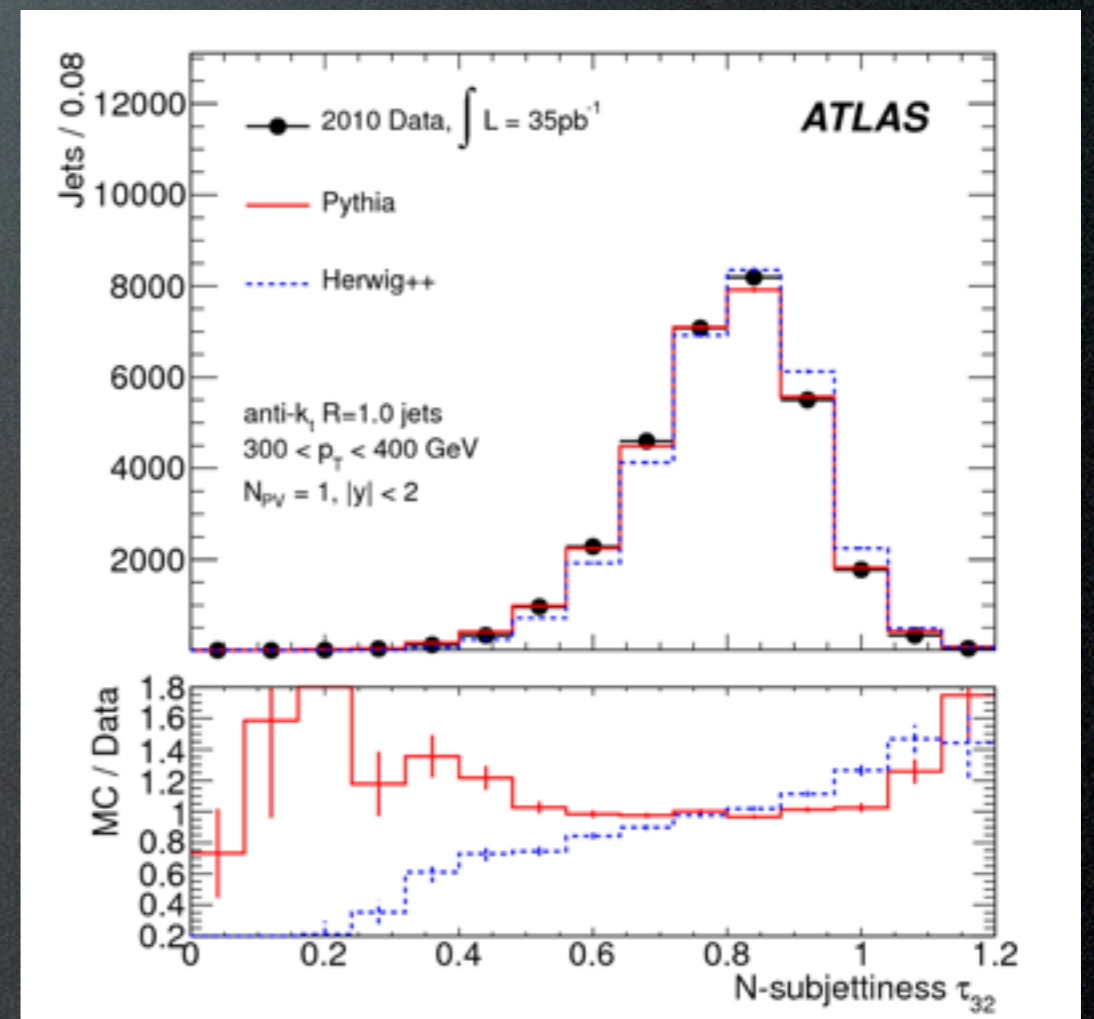
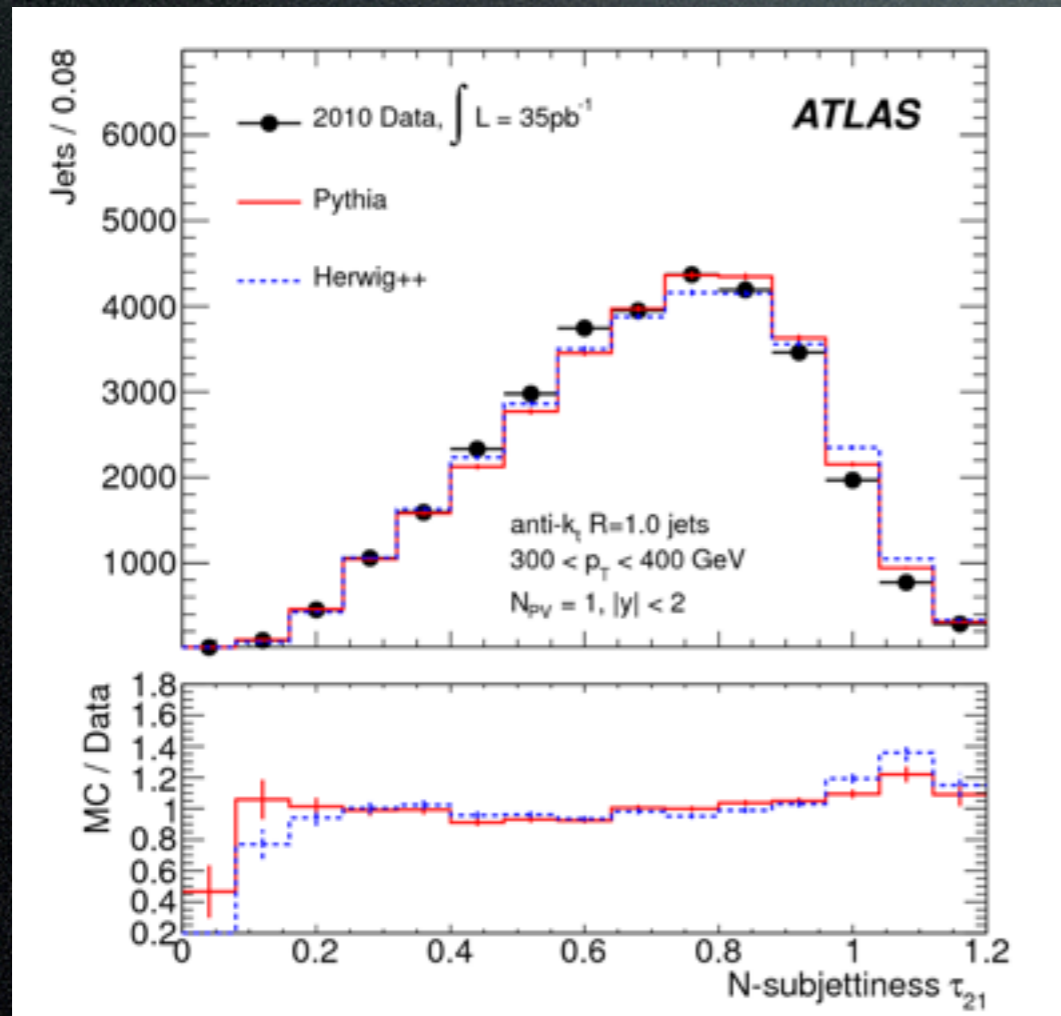

[arXiv:1203.4606](https://arxiv.org/abs/1203.4606)

[arXiv:1203.4606](https://arxiv.org/abs/1203.4606)

W-like

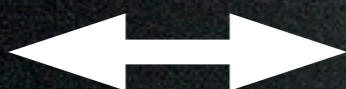

QCD-like

# N-Subjettiness

The ratio of  $\tau_N/\tau_{N-1}$  is used as discriminant



More like 2 subjects than 1



More like 3 subjects than 2

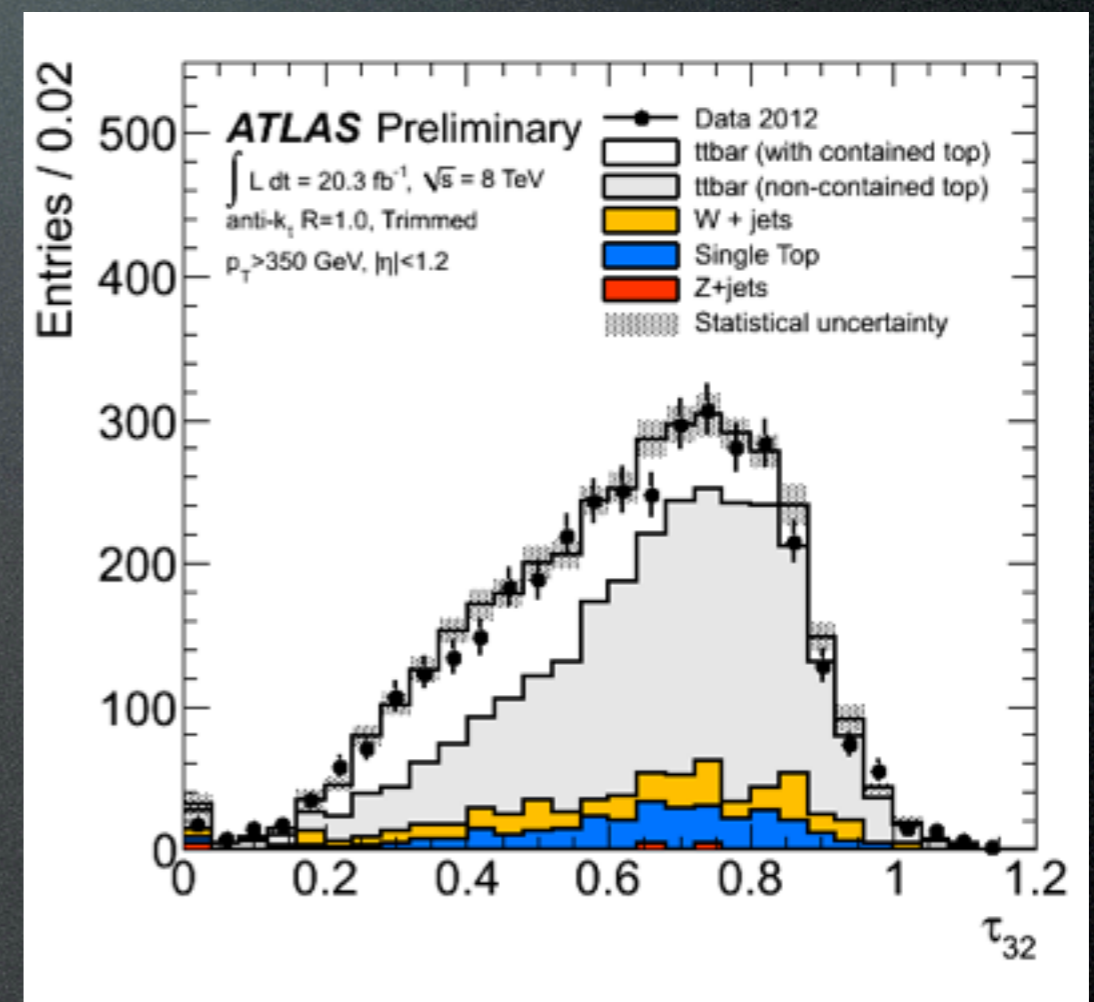
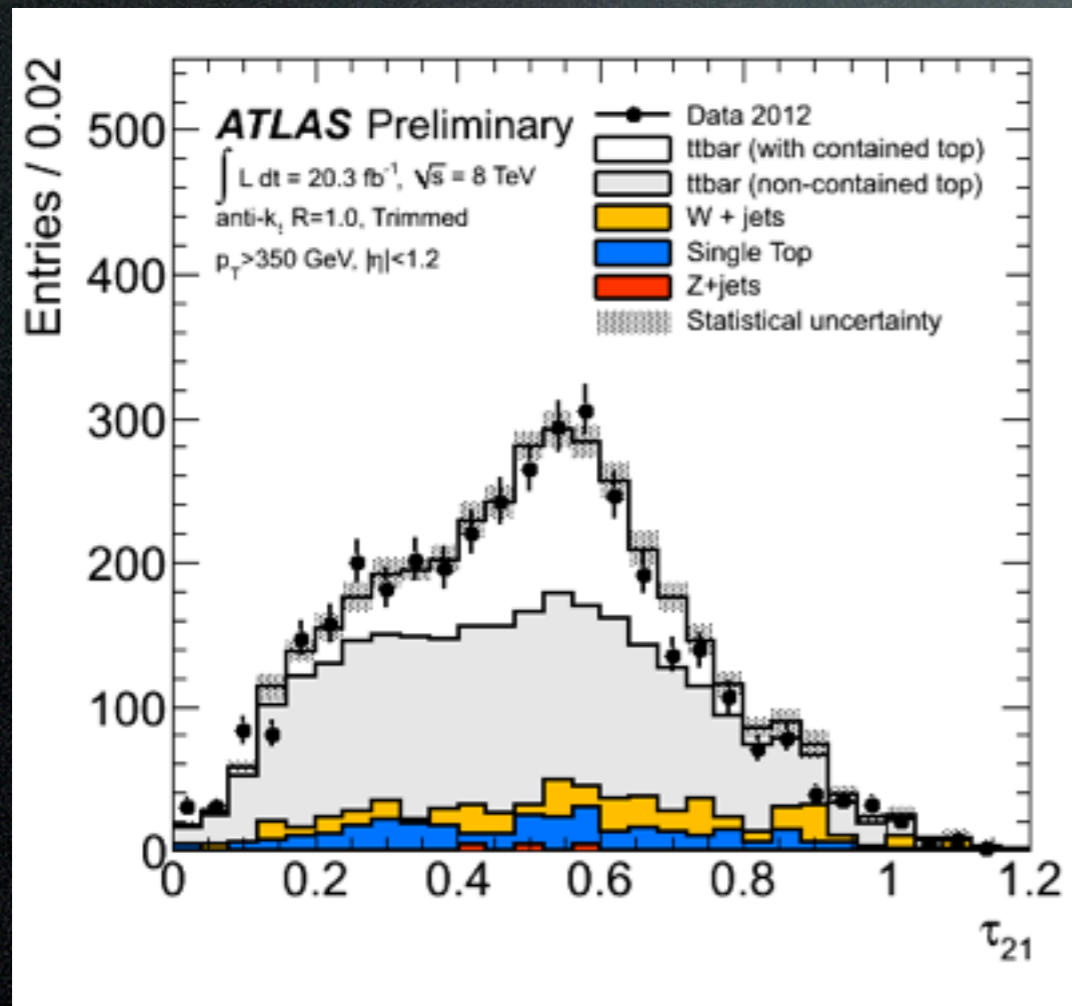

[arXiv:1203.4606](https://arxiv.org/abs/1203.4606)

[arXiv:1203.4606](https://arxiv.org/abs/1203.4606)

W-like

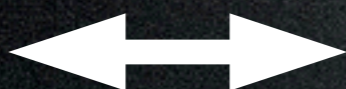

QCD-like

# Angular Correlation Function

(or jet substructure without trees)

$$\mathcal{G}(R) \equiv \sum_{i \neq j} p_{\perp i} p_{\perp j} \Delta R_{ij}^2 \Theta[R - \Delta R_{ij}]$$

$$\Delta R_{ij}^2 = (\eta_i - \eta_j)^2 + (\phi_i - \phi_j)^2$$

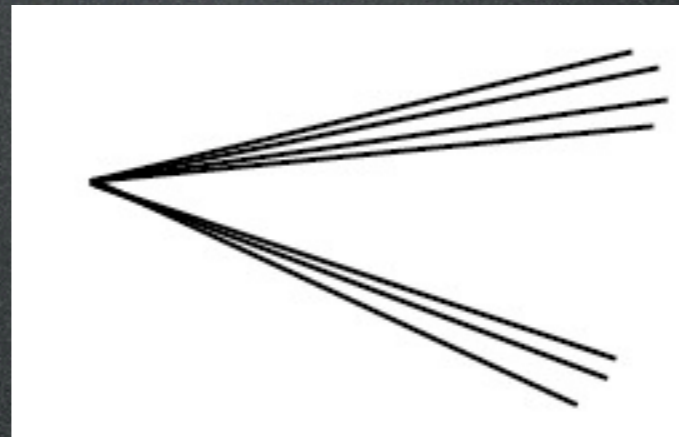
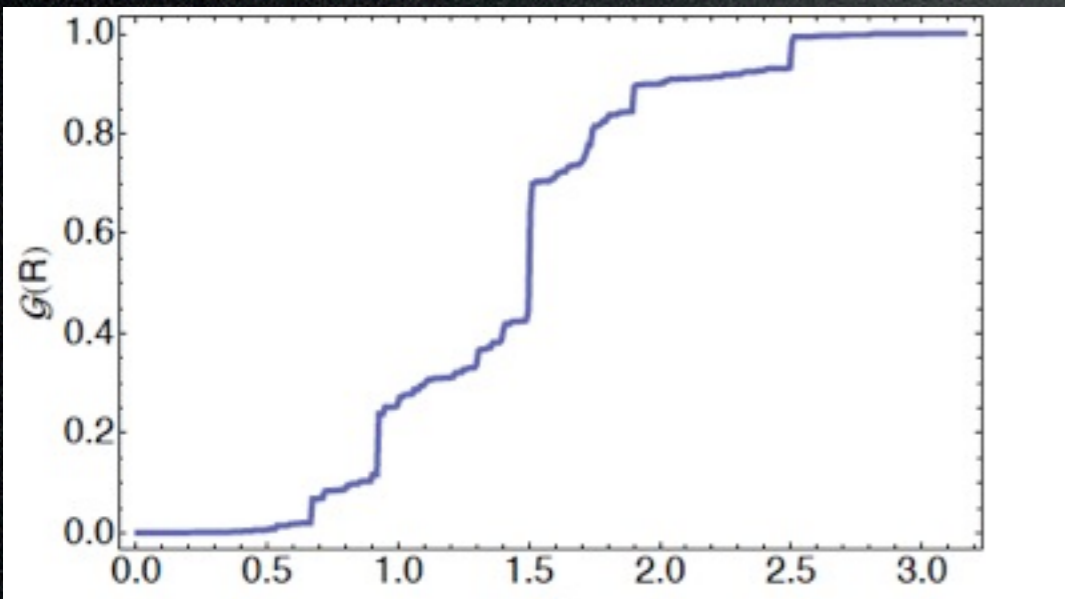

vs.

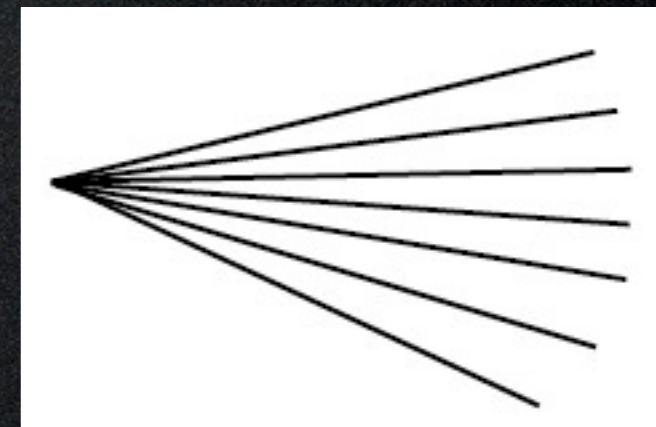

# Angular Structure Function

$$\Delta\mathcal{G}(R) \equiv \frac{d \log \mathcal{G}(R)}{d \log R}$$

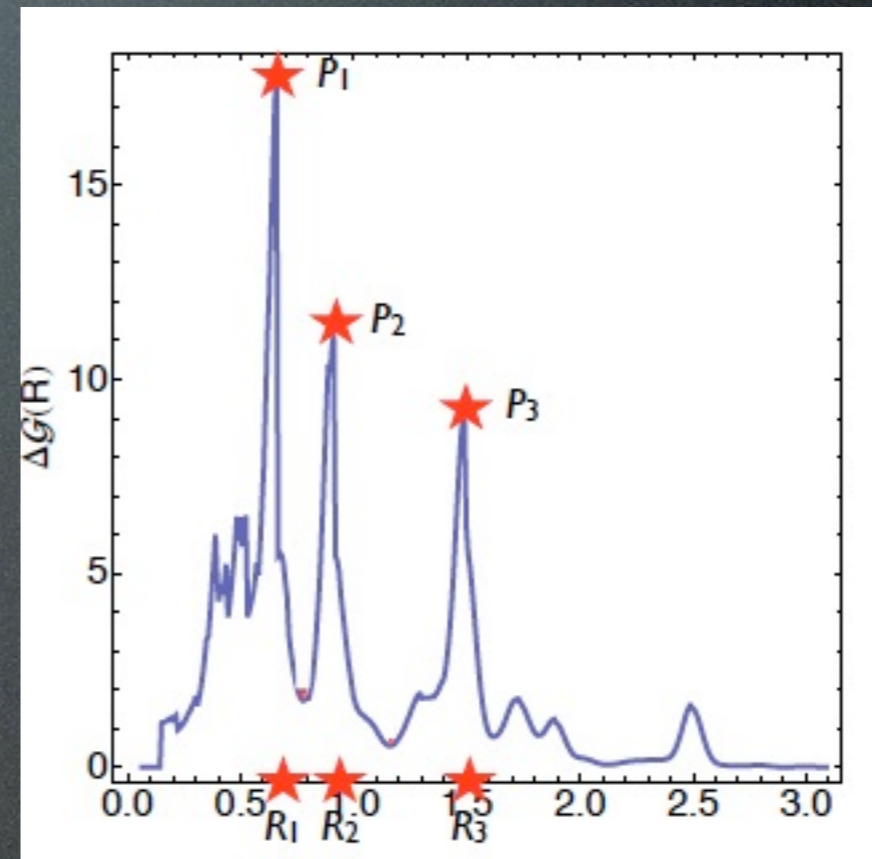
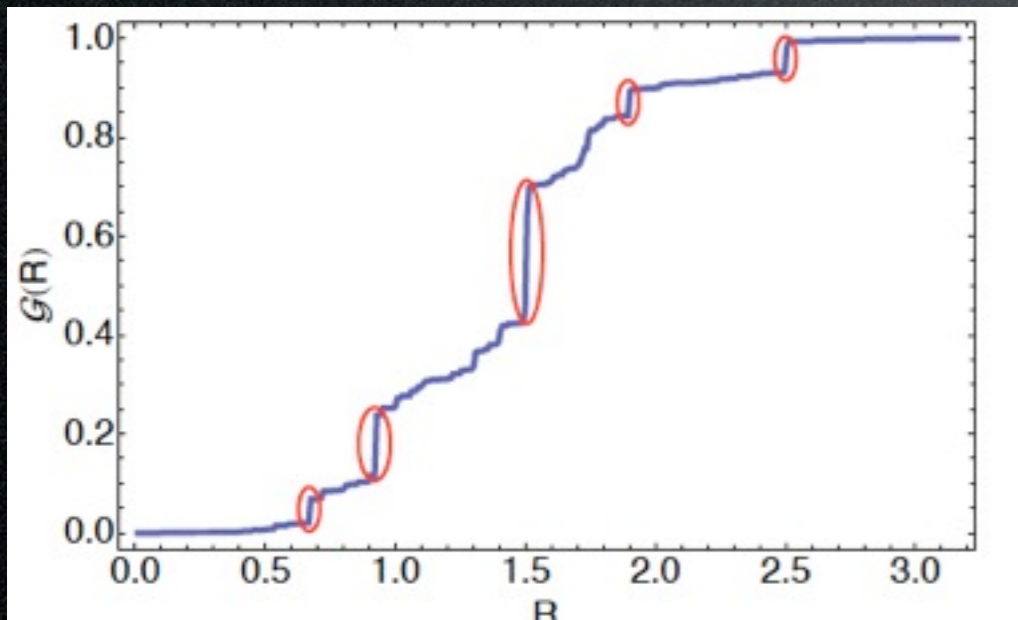

- Location of the peaks
- Height of the peaks
- Number of peaks

# Where it all started: Butterworth-Davidson-Rubin-Salam Higgs to bb tagger (2008)

- Start with fat (C-A 1.2) boosted ( $p_T > 200$ ) b-tagged jet.
- De-cluster the jet. At each stage, mass drop and symmetric splitting requirement.
- Continue till an interesting splitting has been found.
- Higgs candidate from two hardest b-tagged subjets among the three hardest.

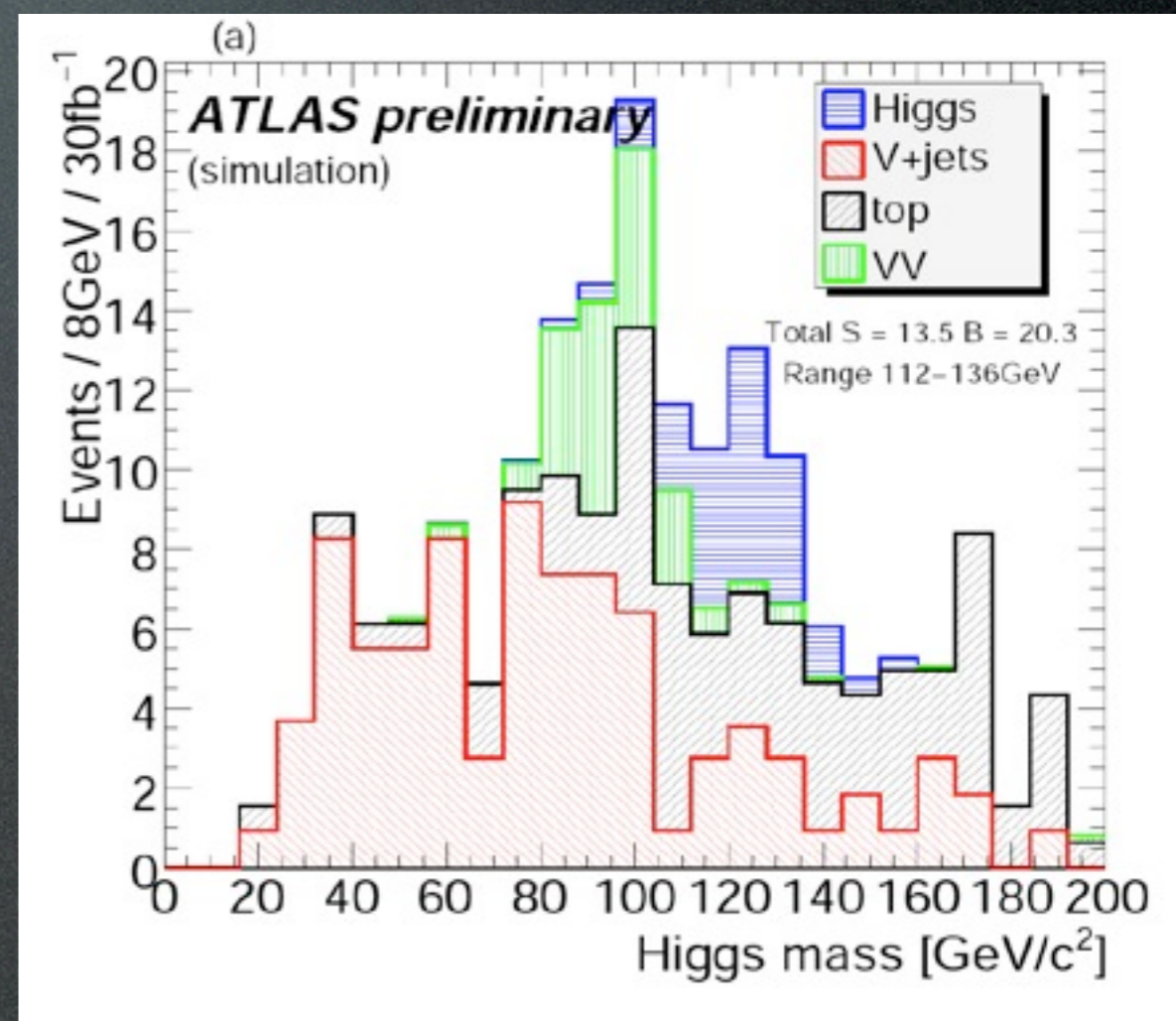

# HEPTopTagger

Browsing through all the branches of jet recombination history

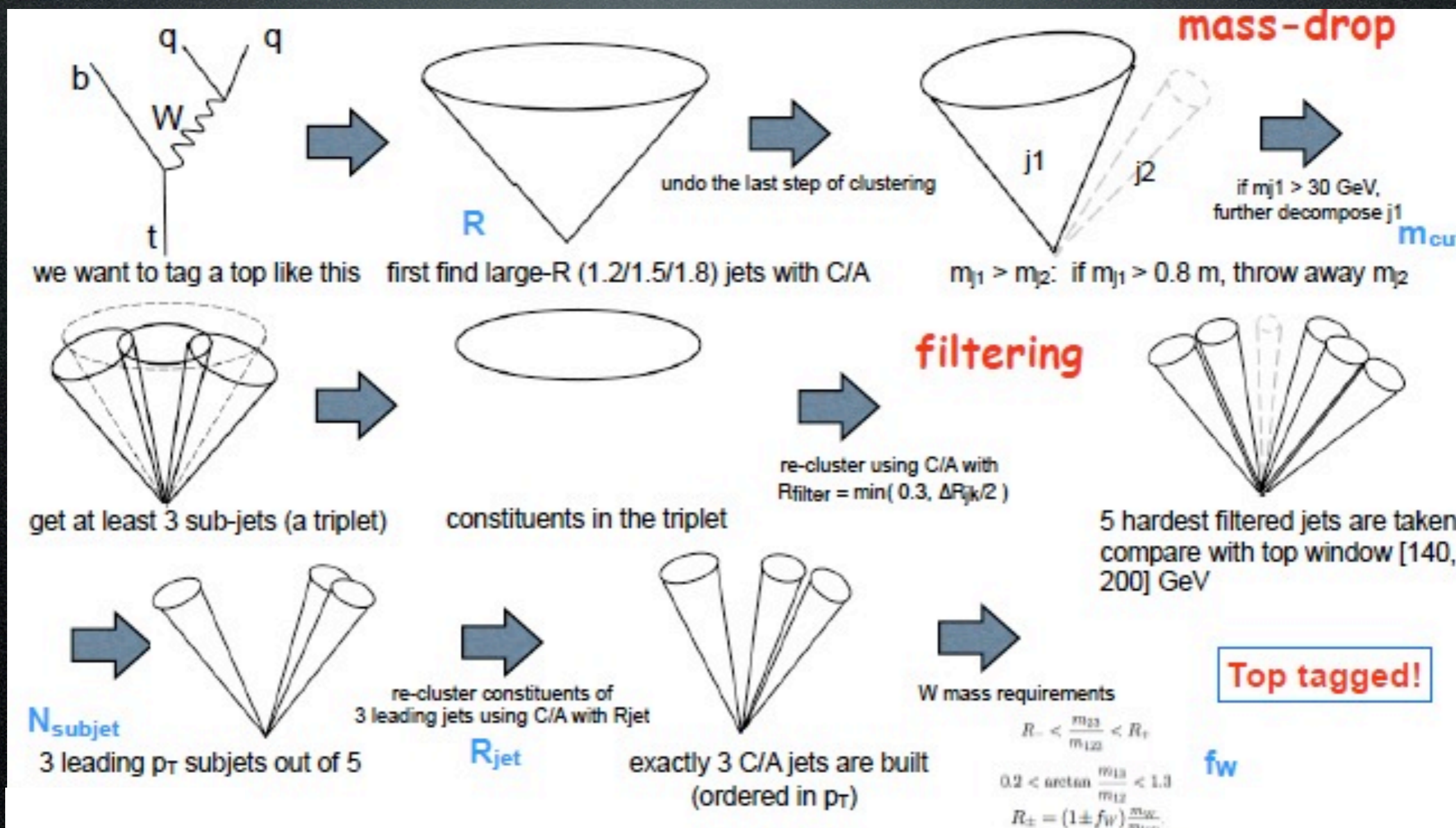
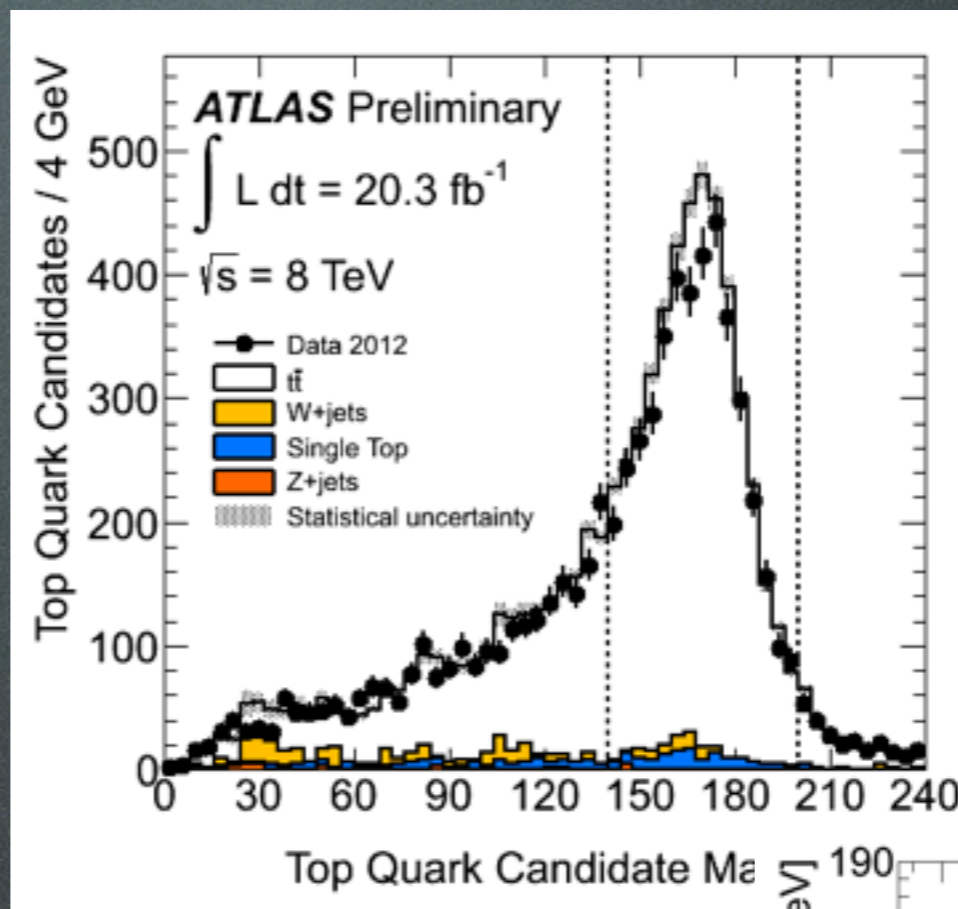
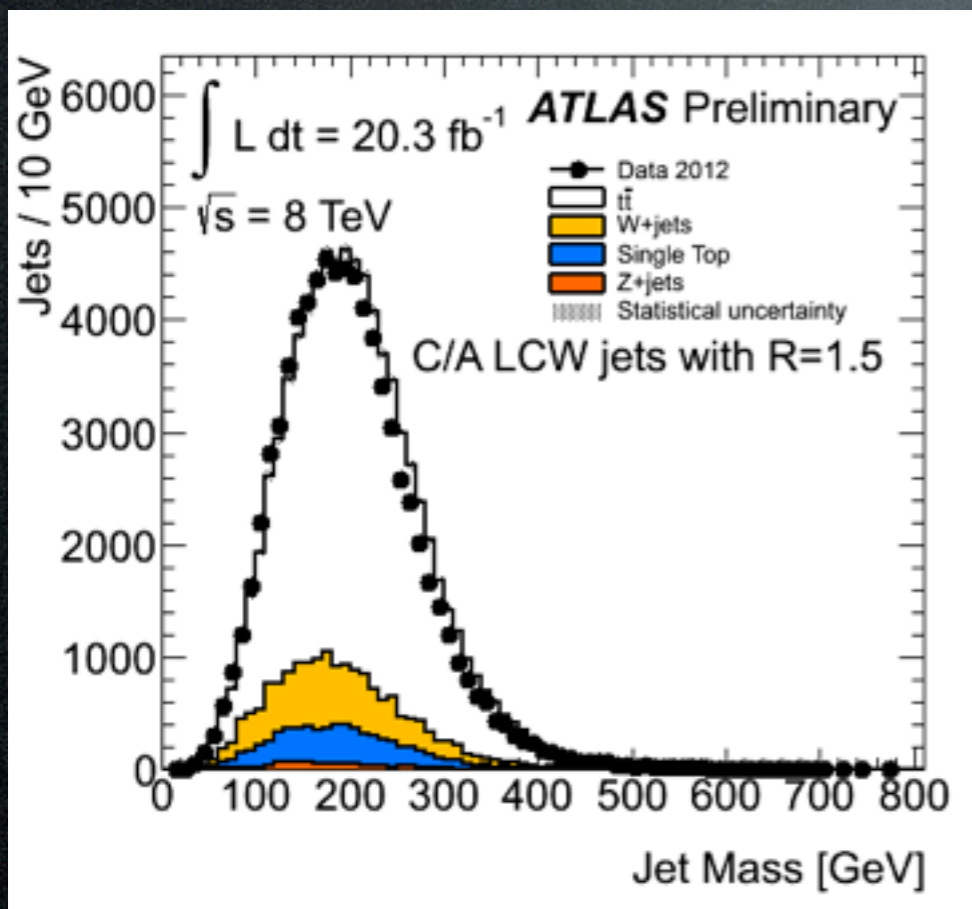

Figure by Xiaoxiao Wang

# HEPTopTagger Performance



Before and after tagging by  
HepTopTagger

Pileup resilience

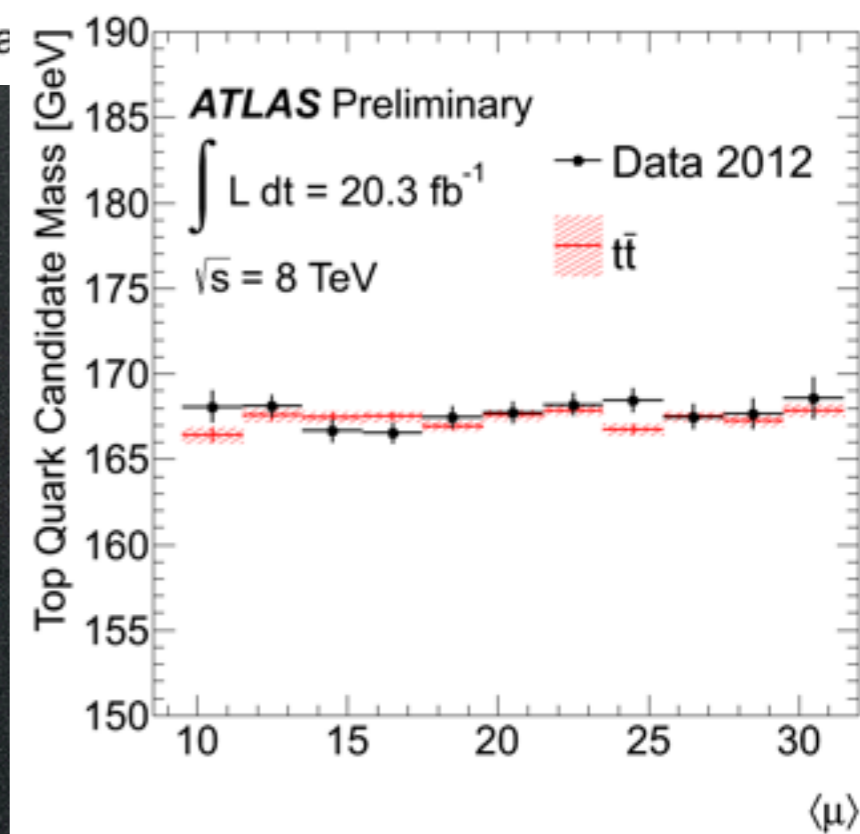

# Detour: Jet Clustering

Distance between two input objects

Distance between each input object and beam

$$d_{ij} = \min(k_{ti}^{2p}, k_{tj}^{2p}) \frac{\Delta y^2 + \Delta \phi^2}{R^2}; \quad d_{iB} = k_{ti}^{2p}; \quad p = \begin{cases} 1 & k_t \\ 0 & \text{Cambridge/Aachen} \\ -1 & \text{anti-}k_t \end{cases}$$

Intrinsic transverse momentum

Fixed “radius” parameter

- Find the smallest of all  $\{d_{ij}, d_{iB}\}$
- If this is one of the  $d_{ij}$  values, inputs  $i$  and  $j$  are merged.
- If it is one of the  $d_{iB}$  values,  $i^{\text{th}}$  input is considered a jet.
- Continue till all inputs are merged into jets.



# Milestones and Prospects

Run I	Commissioning the tools
Run 2: 100 fb <sup>-1</sup>	and... Improve precision of top/W/Higgs mass measurements.  Exclude/severely constraint many of the new physics models with the higher energy reach
Run 3: 300 fb <sup>-1</sup>	and... Directly test the coupling of the Higgs boson to fermions
HL-LHC: 3000 fb <sup>-1</sup>	and... Measure Higgs self coupling Measure vector boson scattering  Observe rare Higgs decays

# PDF Dependence of Tunes

- Changing PDFs change gluon density, so re-tuning is needed.
- ATLAS systematically explored the effect of NLO and modified LO PDFs on the tunes.
- Many matrix element generators use NLO/mLO PDFs, so it is important to understand the effect on matched parton-shower generators.
- LO PDFs generally give the best description, with mLO ones the worst.
- NLO PDFs require less MPI cross-section screening and stronger color reconnection.

# PDF Dependence

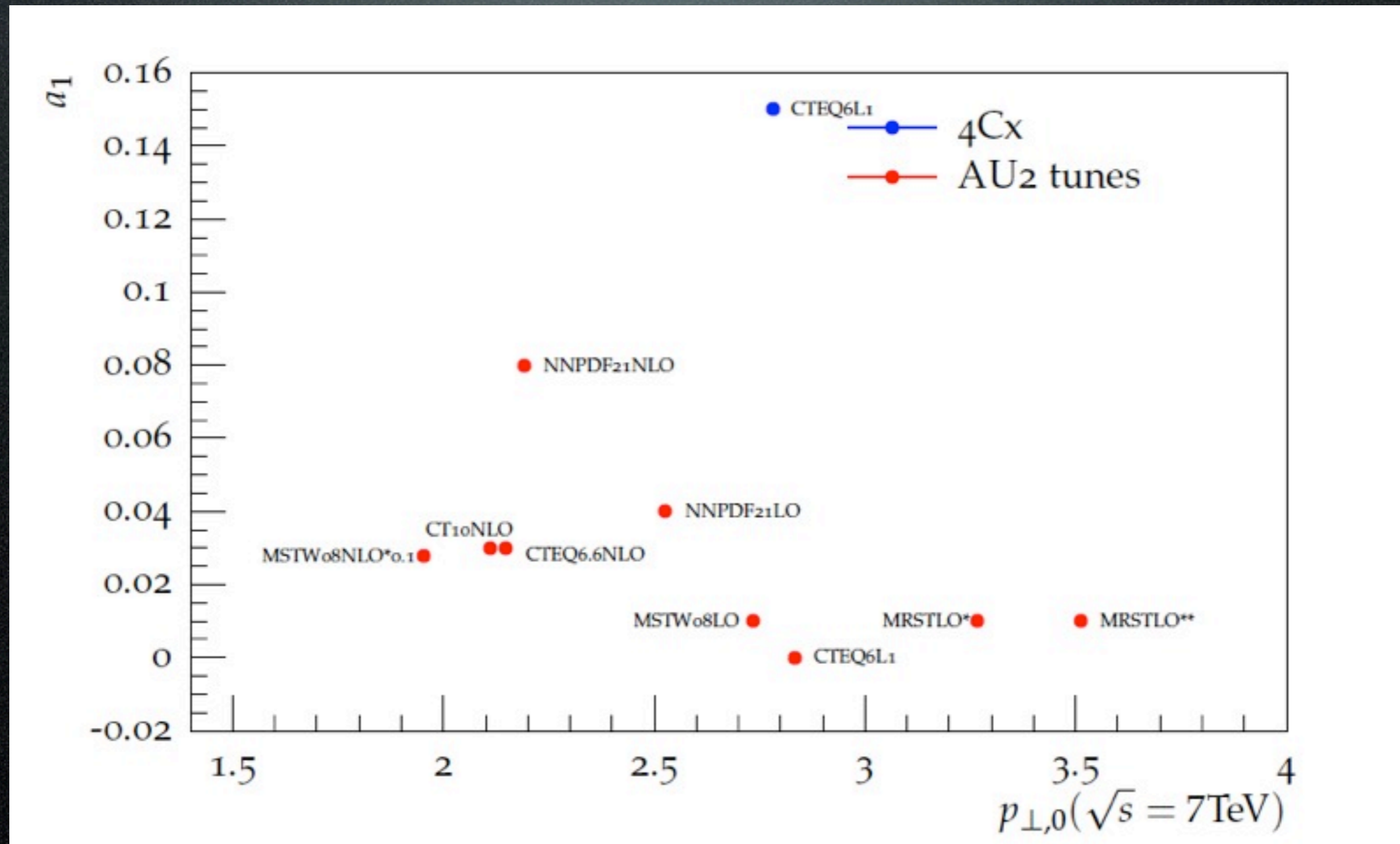

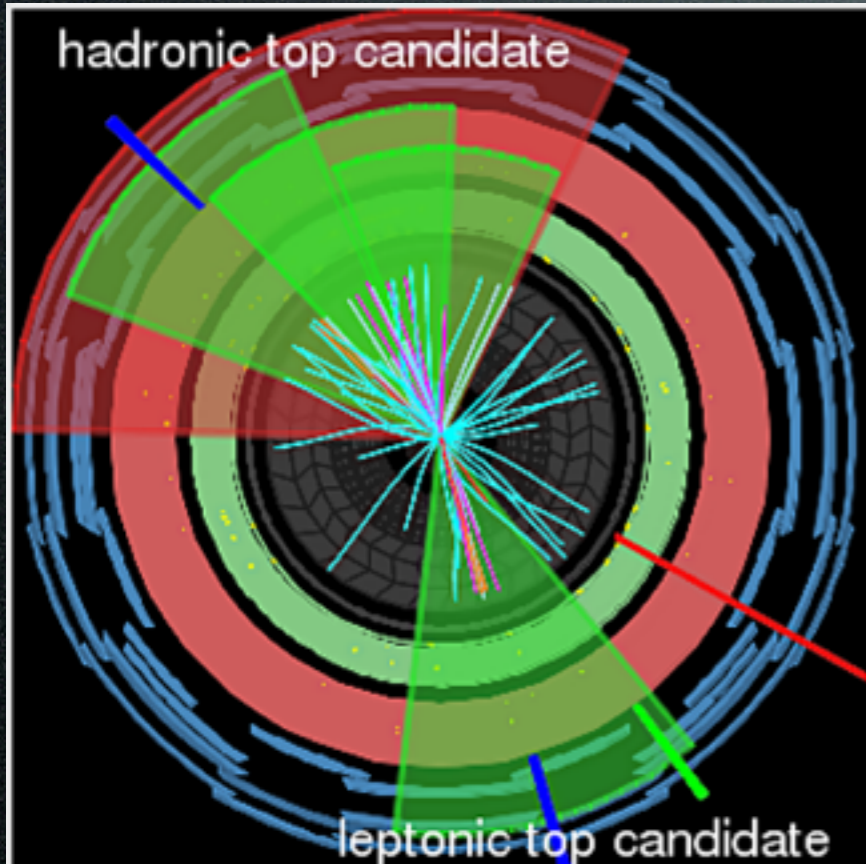

# ATLAS EXPERIMENT

Run Number: 209995, Event Number: 51046560  
Date: 2012-09-09 23:10:22 CEST

